

Shutter Controller

SSH-C2B User's Manual

Ver. 1.0



History

1st edition September 24, 2013

Information on use of this manual and product

Please read this manual thoroughly in order for you to make good use of the product.

(1) Technical information represented on this material is not granted to practice or use rights that Sigma Koki Co.,Ltd. owns including intellectual property rights.

(2) Technical information represented on this material is subject to change without notice, from it of issuing point.

(3) Technical information represented on this material has been written with precision and caution. However, Sigma Koki Co.,Ltd. is not liable for any damage resulting from error or fault in description of this material.

(4) All rights reserved. Preliminarily request written permission from copyright holder, Sigma Koki Co.,Ltd. to reprint or duplicate whole or any part of this material.

Please do not hesitate to contact us for any inquiries regarding the use of product.

Contact information is listed below.

Sigma Koki Co.,Ltd. Tokyo Head office, International sales division

TEL +81-3-5638-8228 / FAX +81-3-5638-6550

E-mail: international@sigma-koki.com

URL: <http://www.sigma-koki.com/>

Contents

For Your Safety	- 3 -
Chapter 1 – Before You Begin	- 4 -
1-1 Package Contents	- 4 -
1-2 Names and Function of Each Part	- 5 -
Chapter 2 Basic Operation	- 7 -
2-1 Operating Procedure.....	- 7 -
2-1-1 Startup Screen	- 8 -
2-1-2 Basic Screen	- 8 -
2-2 Setting of Shutter Type.....	- 9 -
2-2-1 Setup Screen.....	- 9 -
2-2-2 Setting Procedure of Shutter Type	- 10 -
2-2-3 Setup Menu	- 11 -
2-3 Correlation Diagram of Setup Menu	- 12 -
Chapter 3 Advanced Operation	- 13 -
3-1 Timer Mode.....	- 13 -
3-1-1 Timer Mode Function Description.....	- 13 -
3-1-2 Procedure of Timer Setting	- 14 -
3-2 Adding a Shutter Type.....	- 17 -
3-2-1 Type of the Signal Output of the Shutter Control.....	- 17 -
3-2-2 Additional Procedures of Shutter Type.....	- 17 -
3-2-2 Sub-menu of User-defined (USERDEF).....	- 21 -
3-3 Shutter Control by External Input	- 22 -
3-3-1 GATE Mode.....	- 22 -
3-3-2 TRIGGER Mode	- 22 -
3-3-3 Polarity of External Control Signal.....	- 23 -
Chapter 4 Serial Communication	- 24 -
4-1 SSH-C2B / SSH-C4B Common Commands	- 24 -
4-2 SSH-C2B Command	- 26 -
4-2-1 Description.....	- 26 -
4-2-2 Protocol	- 26 -
4-2-2-1 Command Packet	- 26 -
4-2-2-2 Return Packet.....	- 27 -
4-2-3 Command List.....	- 28 -
4-3 SSH-C4B Compatible Command	- 50 -
4-4 USB Driver Installation (Windows7).....	- 51 -

Chapter 5 Demo Application for PC	- 55 -
5-1 Overview.....	- 55 -
5-2 Operation Environment.....	- 55 -
5-3 Installation	- 56 -
5-4 Guideline for Operation Screen	- 58 -
5-4-1 Connection Window	- 58 -
5-4-2 Main Window (Simple Mode)	- 59 -
5-4-3 Main Window (Advanced Mode)	- 59 -
5-4-4 Shutter Edit Window	- 61 -
5-4-5 Store and Retrieve the Parameters	- 62 -
5-4-6 Caution.....	- 62 -
Chapter 6 Specifications	- 63 -
6-1 General Specifications.....	- 63 -
6-2 Performance Specification.....	- 63 -
6-3 Connector Pin Specifications	- 64 -
6-4 Dimensions.....	- 66 -
Chapter 7 Others	- 67 -
7-1 Trouble Shooting.....	- 67 -

For Your Safety



Before using this product, thoroughly read this manual and all warnings or cautions in the documentation provided in order to prevent any damage or property losses, or personal injury that may cause to user or others. After reading this manual, keep it in a safe place for future reference.

Disclaimer of Liability

- ①SIGMA KOKI CO.,LTD. does not accept liability for damages resulting from the use of this product or the inability to use this product.
- ②SIGMA KOKI CO.,LTD. does not accept liability for damages resulting from the use of this product that deviates from that described in the manual.
- ③SIGMA KOKI CO.,LTD. does not accept liability for damages resulting from the use of this product in extraordinary conditions, including fire, earthquakes, and other acts of God, action by any third party, other accidents, and deliberate or accidental misuse.

The Symbols Used in This Manual

Symbols below are used to indicate the exact nature of the warning or caution in order to prevent any damage or property losses or personal injury that may cause to user or others.

 WARNING	 CAUTION
<p>This symbol marks warnings that should be read and used to prevent serious injury or death.</p>	<p>This symbol indicates where caution should be used to avoid possible injury to yourself or others, or damage to property.</p>
<ul style="list-style-type: none"> ●Do not use this product in the presence of flammable gas, explosives, or corrosive substances, in areas exposed to high levels of moisture or humidity, in poorly ventilated areas, or near flammable materials. ●Do not connect or check the product while the power is on. ●Installation and connection should be performed only by a qualified technician. ●Do not touch the internal parts of the products. ●Do not bend, pull, damage, or modify the power, motor or connecting cables. ●Should the product overheat, or should you notice an unusual smell, heat, or unusual noises coming from the product, turns off the power immediately. ●Do not turn on the power in the event that it has received a strong physical shock as the result of a fall or other accident. ●Use dry clothes only for cleaning the equipment. ●Do not touch the product when your hands are wet. 	<ul style="list-style-type: none"> ●When unplugging the product, pull on the plug rather than the cord. ●Because some electrical charge remains after the power has been cut, do not touch the input or output terminals for thirty seconds after the product has been turned off. ●When connecting peripherals to the product, adjust the product's initial setting (parameter settings) to suit the peripheral. ●Turn off the power before connecting the product to other devices. <p>Connection should be performed following the connection diagram.</p> <ul style="list-style-type: none"> ●Before turning the equipment on (or when beginning operations), be sure that you can turn the power off immediately in the event that an abnormality occur. ●Do not repair, modify, or disassemble the product. ●Do not use in outdoors.

Chapter 1 – Before You Begin

1-1 Package Contents

Purchasers of this product are advised to find that the package contains the items listed below. Check the package contents using the following checklist. Contact our International Sales Division as soon as possible in the event that you find that any item is missing or damaged.

SSH-C2B Package (Standard Set)

- | | |
|--|---|
| <input type="checkbox"/> SSH-C2B | 1 |
| <input type="checkbox"/> AC adapter | 1 |
| <input type="checkbox"/> ILOCK connector(attached) | 1 |
| <input type="checkbox"/> Simple User's Manual | 1 |

SSH-C2B Options

- | | |
|--|---------------------------|
| <input type="checkbox"/> Electronic shutter | Part Number: SSH-S |
| <input type="checkbox"/> Electronic shutter | Part Number: SSH-R |
| <input type="checkbox"/> Electronic shutter | Part Number: SSH-25RA |
| <input type="checkbox"/> Shutter cable | Part Number: SSH-CA2-LOAA |
| <input type="checkbox"/> Extension shutter cable | Part Number: SSH-CA2-LOAB |
- ※In case of using more than 4 meter-length cable, please do not use plural cables.
If you want exceeding 4 meter, please make sure to contact us.
- | | |
|---|---------------------------|
| <input type="checkbox"/> USB cable (USB A and USB B (Male)) | Part Number: USB-1, USB-2 |
|---|---------------------------|
- ※Please use a cable for PC connection.
- | | |
|---------------------------------------|--|
| <input type="checkbox"/> RS232C cable | Part Number: RS232C/STR-1.8, RS232C/STR-4,
RS232C/STR-5 |
|---------------------------------------|--|
- ※Please use a cable for PC connection.

1-2 Names and Function of Each Part

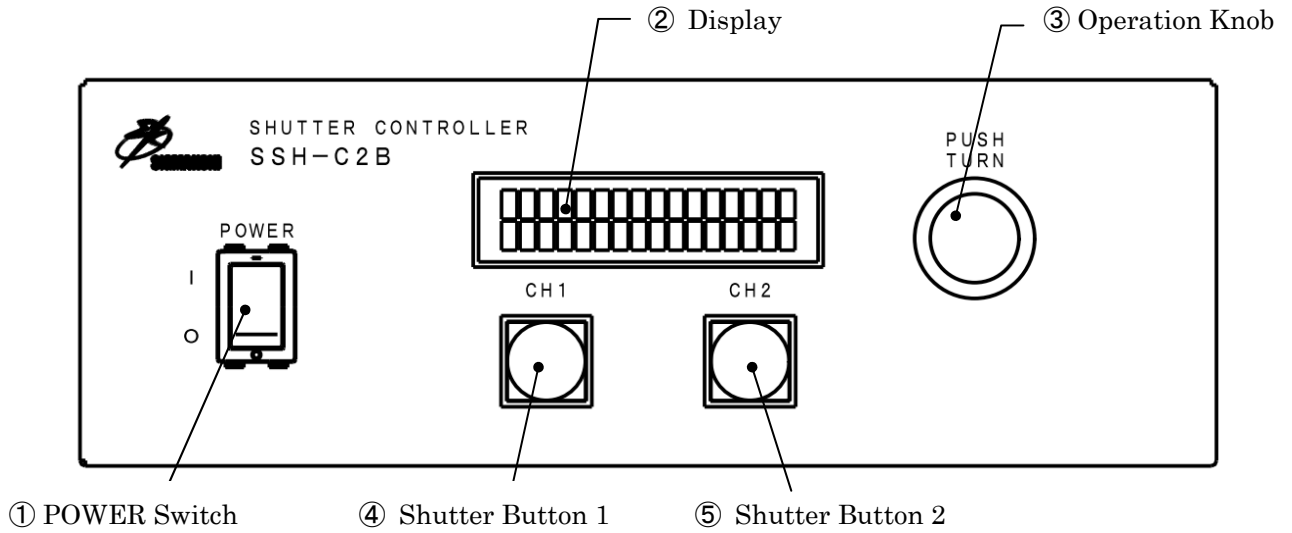

Fig. 1-1 Front Panel

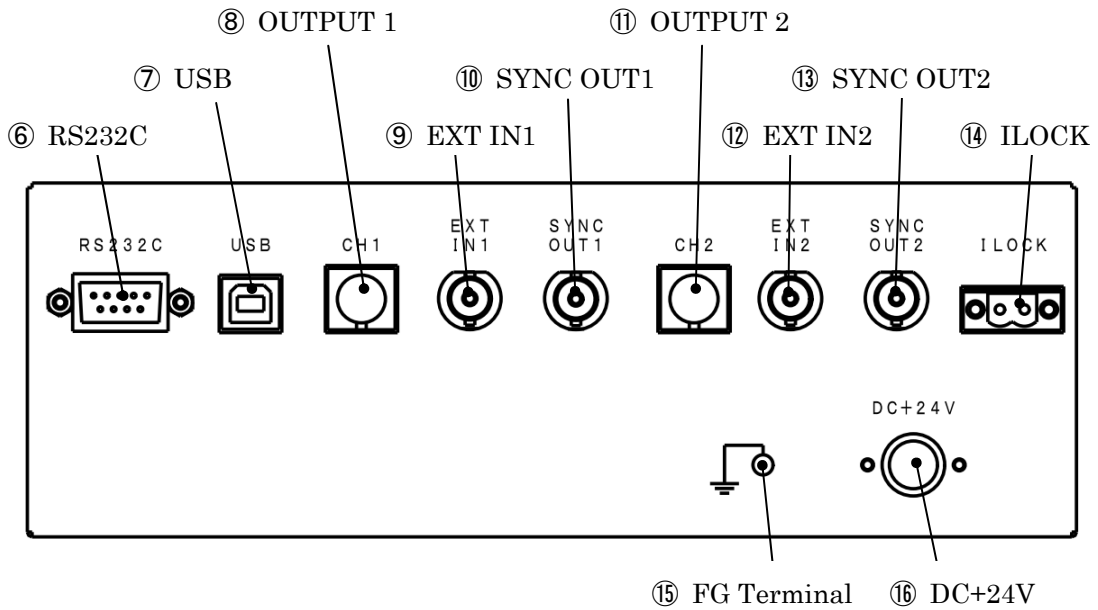



Fig. 1-2 Back panel

- ①POWER Switch : Power is on/off when the switch is set to ON/OFF.
- ②Display(LCD) : Type of shutter, opening and closing status are displayed in the normal mode. Each parameter in the shutter control is displayed by setting mode.
 Please refer to Chapter2 for more information.
- ③Operation Knob : To set parameters.
- ④Shutter Button 1 : Press when you open and close the shutter of CH1 side. LED is lit when the shutter open.
- ⑤Shutter Button 2 : Press when you open and close the shutter of CH2 side. LED is lit when the shutter open.
- ⑥RS232C : For serial communication control.
- ⑦USB : For USB serial communication control.
- ⑧OUTPUT1 : For shutter control of CH1 side.
- ⑨EXT IN1 : To open and close the shutter CH1 side by the external signal.
- ⑩SYNC OUT1 : Synchronization signal in response to opening and closing of the shutter of CH1 side is output. The output is 0 ~ 5V square wave.
- ⑪OUTPUT2 : For shutter control of CH2 side.
- ⑫EXT IN2 : To open and close the shutter CH2 side by the external signal.
- ⑬SYNC OUT2 : Synchronization signal in response to opening and closing of the shutter of CH2 side is output. The output is 0 ~ 5V square wave.
- ⑭ILOCK : Connect the ILOCK connector. When the connector is removed, it becomes ILOCK status. All shutters are closed then.
- ⑮Functional Ground : Please connect to electrical grounding for your safety.
- ⑯DC+24V : Connect to exclusive use AC adapter. Do not use the adapter other than the attached.

~ For the control knob operation ~

The parameters can be set by the knob operation, which is simple and intuitive.

- ◆ Press : operate for the movement of setup screen, decision of items, edit of numerical value, it navigates the place.
- ◆ Turn : operate for the change of menu, change of parameters and increase/decrease of values.

PUSH



PUSH (decision,
movement of digits)

TURN



TURN (change of parameters,
(increase/decrease of value)

Chapter 2 Basic Operation

2-1 Operating Procedure

1 Connection of the shutter and SSH-C2B

Make sure that power is not applied to this product, and connect the shutter to the output connector of this product.

2 Connection of the ILOCK connector

Connect the SSH-C2B and ILOCK connector that came with the package.

3 Connect the AC adapter

Connect the SSH-C2B and AC adapter that came with the package.

4 Turning-on of the power supply

Put the upper power switch of this product, turning on the power.

On power up, the shutter button and LCD backlight blinks three times for the lamp check.

The firmware version is displayed on the LCD.

5 Setting of shutter type

This product is preset to optimal driving conditions by selecting a shutter type.

 Please refer to Section 2-2.

※After setting the shutter type, the shutter is closed when the power is on.

Please be careful, depending on the type including SSH-R, etc, the shutter is operated during the power-on.

6 Opening and closing of the shutter

Make the opening and closing of the shutter by pressing the shutter button.

2-1-1 Startup Screen

On power up, the shutter button and LCD backlight blinks three times for the lamp check. The firmware version is displayed on the LCD.

	I	n	i	t	i	a	l	i	z	i	n	g	.	.	.
				1	.	0	0	,	0	0	1				

Fig. 2-1 Startup screen

2-1-2 Basic Screen

Start-up, and then the basic screen automatically come. The state of CH1 is displayed on the left side of the screen, and the status of CH2 is displayed on the right side of the screen.

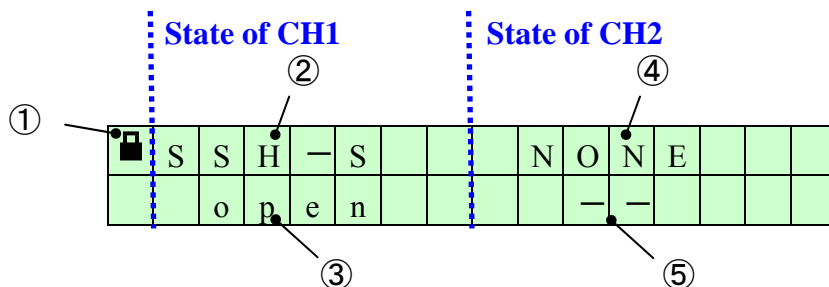

Fig. 2-2 Basic screen

- ①Inter Lock : In the inter lock status, lock icon appears in the upper left of the screen. All shutters are closed in the inter lock status. It is not possible to open the shutter although a command is given. The inter lock will be unlocked by electrical short-circuiting the line of ILOCK connector.
- ②CH1 shutter type : The shutter type set by the CH1 side is displayed. The shutter type has not been selected at the shipment from a factory.
- ③CH1 STATUS : Open or closed status of the shutter, which is connected to CH1 is displayed.
- — — : Shutter type unselected
 - close : Shutter closed
 - open : Shutter open
 - wait : Shutter closed at the timer mode, waiting status to start
- ④CH2 shutter type : The shutter type set by the CH2 side is displayed. A shutter type has not been selected at the shipment from a factory.

- ⑤CH2 STATUS : Open or closed status of the shutter, which is connected to CH2 is displayed.
- — — : Shutter model unselected
 - close : Shutter closed
 - open : Shutter open
 - wait : S Shutter closed at the timer mode, waiting status to start

2-2 Setting of Shutter Type

This product is preset to optimal driving conditions by selecting a shutter type. Set the optimal shutter type before operating the shutter.

2-2-1 Setup Screen

Setup screen is displayed when the knob is pressed in the base screen.

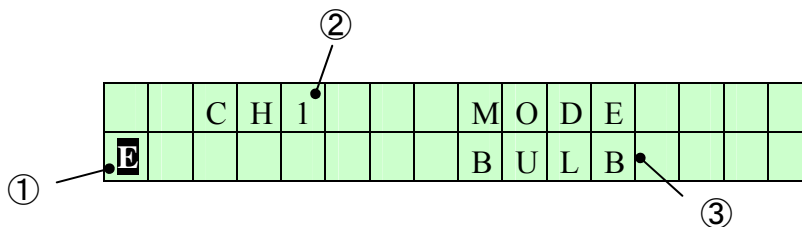

Fig. 2-3 Setup screen

- ①Edit icon : Edit icon is displayed in the lower-left corner of the screen during the change of setting.
- ②Setup menu : Setup menu is displayed in the upper line of the screen.
Menu is changed by turning knob to the left or right.
👉 Please refer to Section 2-2-3 Setup menu for details
- ③Setup value : Setup value is displayed. It is possible to edit the values and parameters by pressing knob. The value is flashing during the change. The value is determined by pressing the knob again. Please make sure to save the settings in EXIT menu.

2-2-2 Setting Procedure of Shutter Type

The procedure of setting the shutter as 『SSH-S』 is shown below.

1. Basic screen

		N	O	N	E					N	O	N	E		
		-	-							-	-				

 $\times 1$: Setup screen is displayed when the knob is pressed.

2. Setup screen

		C	H	1						M	O	D	E		
E										B	U	L	B		

 : You can change the menu by turning the knob.

3. Shutter selection menu

		C	H	1						M	O	D	E	L	
E										N	O	N	E		

 $\times 6$: You can change the menu by turning the knob.

 $\times 1$: It is possible to change the shutter type by pressing the knob.
The value is flashing during the change.

4. Selection of shutter type

		C	H	1						M	O	D	E	L	
E										S	S	H	-	S	

 $\times 2$: Changing the shutter type.

 $\times 1$: Shutter type is determined.

5. Save of setting

		E	X	I	T										
E										<	P	U	S	H	>

 $\times 18$: Set to EXIT menu. (far right of the menu)

 $\times 1$: Exit menu is displayed by pressing the knob.

 $\times 1$: Move the cursor to YES.



 $\times 1$: Settings are saved by pressing the knob, return to the Basic screen.

※ Select the CANCEL if you undo the setting, or select the NO if you do not want to save.

		S	A	V	E	?				Cursor	C	A	N	C	E	L
E		Y	E	S							N	O				

2-2-3 Setup Menu

Table 1-1 Setup menu

SW	No.	Name of menu	Details	Setting value	Default value
Left 	1	CH1 MODE	Shutter mode selection of CH1 ※ 1	BULB/TIMER	BULB
	2	CH1 SPEED	Shutter-speed setting of CH1 ※ 2	0.2ms~99,999s (MAX 27hour46.5minute)	1,000ms
	3	CH1 SPDUNIT	Shutter-speed unit setting of CH1	(ms)/(sec)/(Hz)	ms
	4	CH1 DELAY	Delay time setting of CH1 ※ 2	0ms~999.9ms	0ms
	5	CH1 REP-CNT	Set the number of repeat count of CH1 ※ 2	1~999,999 count	1
	6	CH1 REP-FRQ	Setting the repeat frequency of CH1 ※ 2	0.1~500.0Hz	0.5
	7	CH1 MODEL	Shutter model selection of CH1 ※User can be added to three shutter models in USERDEF.	NONE/SSH-R/SSH-S/SHPS/SSH25RA/ user1/user2/user3	NONE
	8	CH1 COUNTER	Opening and closing number of times of CH1 ※Performing a reset by continue to press the operation knob.	MAX 1,000,000,000 count	0
	9	CH2 MODE	Shutter mode selection of CH2 ※ 1	BULB/TIMER	BULB
	10	CH2 SPEED	Shutter-speed setting of CH2 ※ 2	0.2ms~99,999s (MAX 27hour46.5minute)	1,000ms
	11	CH2 SPDUNIT	Shutter-speed unit setting of CH2	(ms)/(sec)/(Hz)	ms
	12	CH2 DELAY	Delay time setting of CH2 ※ 2	0ms~999.9ms	0ms
	13	CH2 REP-CNT	Set the number of repeat count of CH2 ※ 2	1~999,999 count	1
	14	CH2 REP-FRQ	Setting the repeat frequency of CH2 ※ 2	0.1~500.0Hz	0.5
Right 	15	CH2 MODEL	Shutter model selection of CH2 ※User can be added to three shutter models in USERDEF.	NONE/SSH-R/SSH-S/SHPS/SSH25RA/ user1/user2/user3	NONE
	16	CH2 COUNTER	Opening and closing number of times of CH2 ※Performing a reset by continue to press the operation knob.	MAX 1,000,000,000 count	0
	17	IO MODE	Selection of external input mode	GATE/TRIGGER	GATE
	18	IO ACTIVE	Selection of the external input signal polarity	HIGH/LOW	HIGH
	19	LCD LIGHT	Selection of the LCD backlight ※If set to "5secON", 5 seconds back light will illuminate when Operate the knobs and switches on the front panel	ON/OFF/5secON	ON
	20	BUTTON LIGHT	Selection of the button LED lighting When set to "ON", LED is lit while the shutter is open	ON/OFF	ON
	21	CMD MODE	Selection of command system SSH-C2B is a new command system, SSH-C4B is an old command system.	SSH-C2B/SSH-C4B	SSH-C2B
	22	RS232C B-RATE	Selection of baud rate	9600/19200/38400	9600
	23	USERDEF	Transition to sub-menu of user-defined ※Transition to sub-menu when the knob is pressed.	▼  Please refer to Section 3-3-2 for more information	-
	24	SYSTEM RESET	System reset ※After selecting YES, and then perform a system reset by press and hold knob	NO/YES	NO
	25	EXIT	Exiting setup mode. Exit menu is displayed when the knob is pressed	<push>	-

※ 1 BULB mode operates to open and close as commanded. Time adjustment is possible for delay time and shutter-speed and repeat in TIMER mode.

 Please refer to Chapter 3, "Advanced Operation" for more information.

※ 2 Set this product to the TIMER mode to be enabled.

2-3 Correlation Diagram of Setup Menu

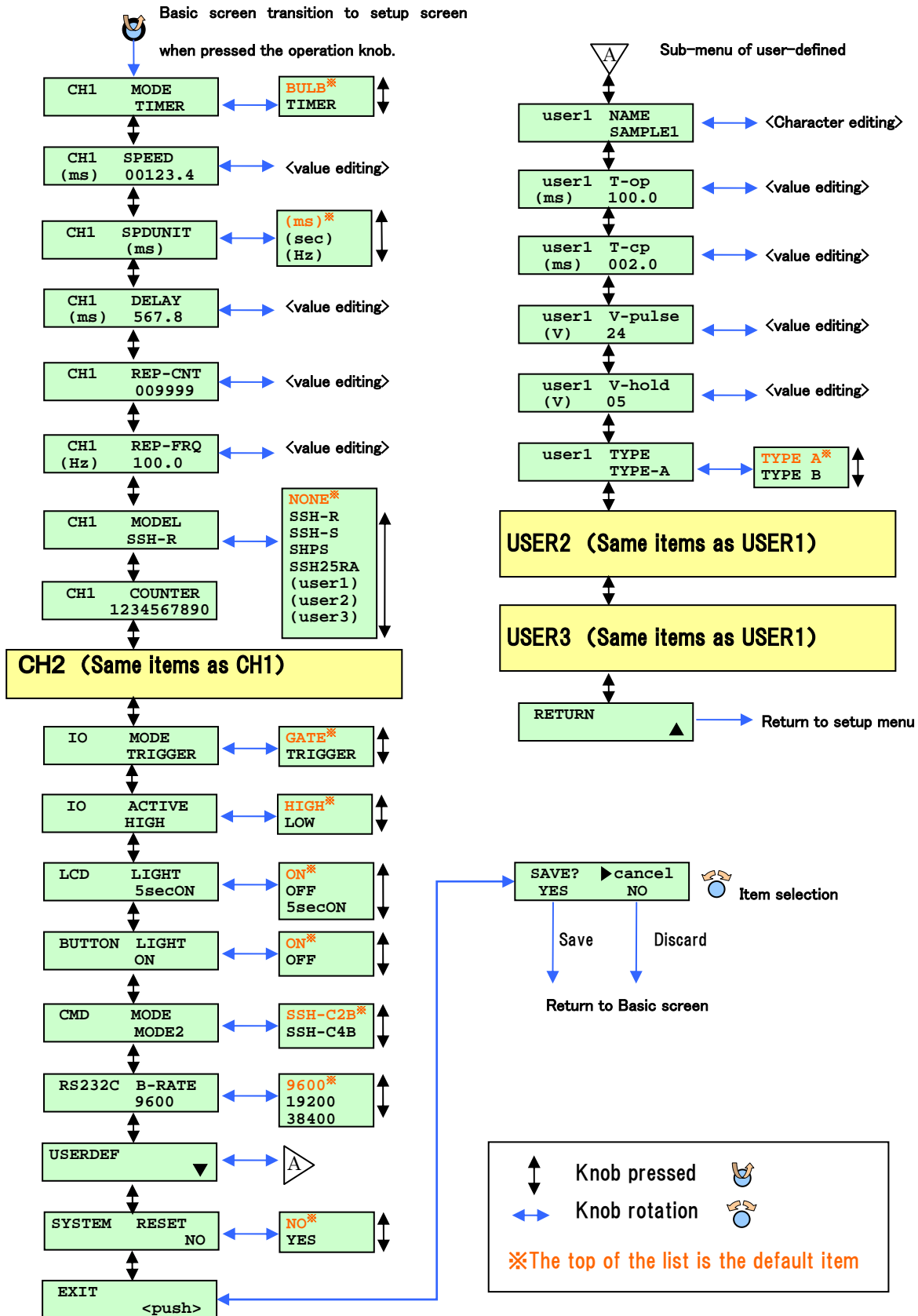

Fig. 2-4 Correlation diagram of the setup menu

Chapter 3 Advanced Operation

3-1 Timer Mode

3-1-1 Timer Mode Function Description

Timer mode is a function of the shutter controlled by the built-in timer in this product. Timer mode can set the delay time, shutter speed, frequency of repetitions, and number of repetitions. It can adjust the time for opening and closing as well. Because the BULB mode is the default mode, please switch to timer mode in the setup screen.

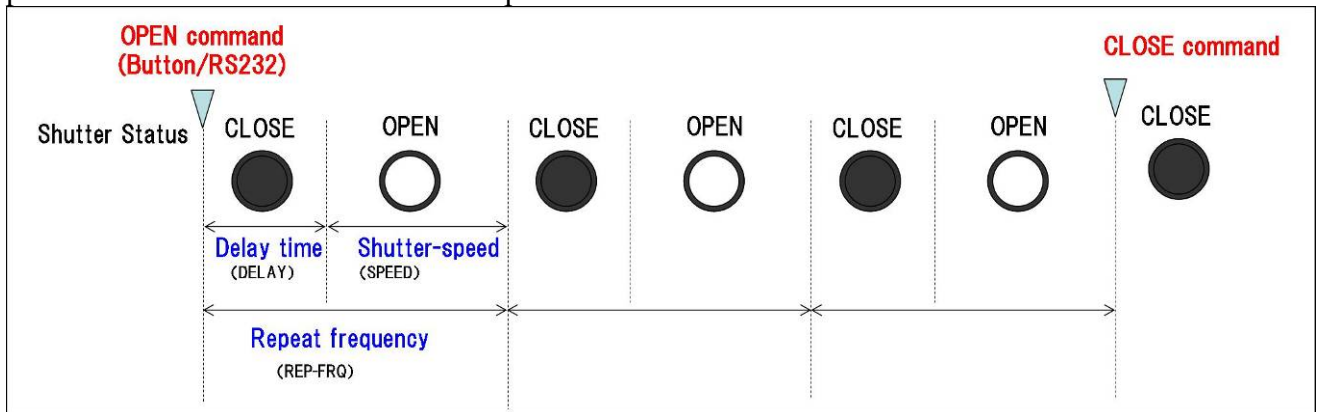

Fig. 3-1 Timer mode operation (In the case of three times in repetition)

- ① Delay time: Timer mode is the waiting time to give a signal to open the shutter actually from giving an OPEN command. External input for commands is not taken into account in the delay time.
- ② Shutter-speed: how long the shutter stays open. More precisely, the shutter speed is the time from the start of the shutter's OPEN pulse signal to the CLOSE command. In case of setting shutter speed by 10 sec or more, the number of repetitions will be automatically one.
- ③ Repeat frequency (REP-FRQ): REP-FRQ is equivalent to the time required for the opening and closing once. As setting the frequency of repetition, the ratio of opening and closing is determined by the relationship of the shutter speed and the frequency of repetition. In addition, when using the TYPE-B shutter, it is the relationship like Fig.3-2 that the shutter closing motion is entered.
- ④ Repeat count (REP-CNT): The number of times to open and close the shutter repeatedly. When the number of repetitions is set, it repeats open and close automatically as long as you do not provide the CLOSE command to give an OPEN command once. A single OPEN command will carry out the specified number of times for opening and closing the shutter.

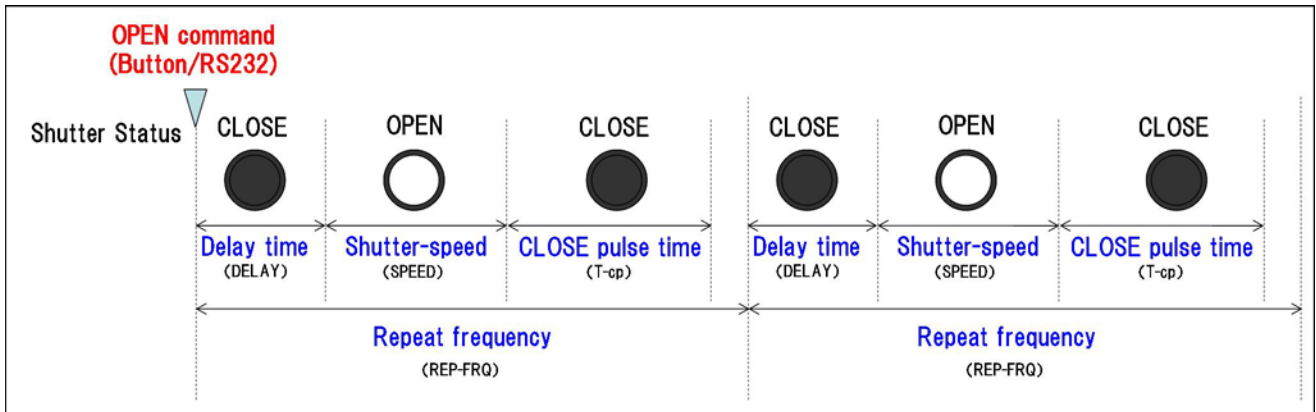

Fig. 3-2 Timer mode operation of the TYPE-B shutter setting

3-1-2 Procedure of Timer Setting

The following shows the steps to set the timer of CH1.

1. Basic screen

		N	O	N	E					N	O	N	E				
		-	-							-	-						

PUSH



×1

: Setup screen is displayed when the knob is pressed.

2. Setup screen

				C	H	1						M	O	D	E		
												B	U	L	B		

TURN



×1

: You can change the menu by turning the knob.

3. Selection of the timer mode

				C	H	1						M	O	D	E		
												T	I	M	E	R	

PUSH



×1

: Press the knob to switch to the changing display. The value is flashing during the change.

TURN



×1

: Selection of timer mode.

PUSH



×1

: The value is determined by pressing the knob.

4. Setting of shutter speed

		C	H	1				S	P	E	E	D			
█		(m	s)			0	0	1	0	0	.	0	

 $\times 1$: Set to SPEED menu of CH1.

 : Press the knob to switch to the changing display. The value is flashing during the change. During the change, the position is moved by pressing the knob. When the flashing is stop, the change is completed.

 : The number can be increased and decreased. When the value is not flashing, the sub-menu item can be changed by turning the knob.

5. Setting of delay time

		C	H	1				D	E	L	A	Y			
█		(m	s)			0	0	0	.	0			

 $\times 2$: Set to DELAY menu of CH1.

 : Press the knob to switch to the changing display. The value is flashing during the change. During the change, the position is moved by pressing the knob. When the flashing is stop, the change is completed.

 : The number can be increased and decreased. When the value is not flashing, the sub-menu item can be changed by turning the knob.

6. Setting of number of repetitions

		C	H	1				R	E	P	-	C	N	T	
█								0	0	0	0	0	1		

 $\times 1$: Set to REP-CNT menu of CH1.

 : Press the knob to switch to the changing display. The value is flashing during the change. During the change, the position is moved by pressing the knob. When the flashing is stop, the change is completed.

 : The number can be increased and decreased. When the value is not flashing, the sub-menu item can be changed by turning the knob.

7. Setting of frequency of repetitions

		C	H	1				R	E	P	-	F	R	Q	
█		(H	z)			0	0	0	.	5			

TURN  ×1 : Set to REP-FRQ menu of CH1.

PUSH  : Press the knob to switch to the changing display. The value is flashing during the change. During the change, the position is moved by pressing the knob. When the flashing is stop, the change is completed.

TURN  : The number can be increased and decreased. When the value is not flashing, the sub-menu item can be changed by turning the knob.

8. Save of setting

	E	X	I	T												
█											<	P	U	S	H	>

TURN  ×19 : Set to EXIT menu. (far right side of the menu)

PUSH  ×1 : EXIT menu is displayed by pressing the knob.

	S	A	V	E	?			Cursor	C	A	N	C	E	L	
█		Y	E	S					N	O					

TURN  ×1 : Move the cursor to YES.

PUSH  ×1 : Settings are saved by pressing the knob, return to the Basic screen.

※ Select the CANCEL if you undo the setting, or select the No if you do not want to save.

3-2 Adding a Shutter Type

This product can be added by 3 types of user-defined shutter and also be set any of the voltage and pulse width.

3-2-1 Type of the Signal Output of the Shutter Control

This product allows a choice between two types of shutter control output signals: TYPE-A and TYPE-B. TYPE-A shutter opens on a positive pulse. It uses its own spring feature as a mechanism for closing the shutter. TYPE-B shutter opens on a positive pulse and closes on a negative pulse. There is no need to set the OPEN and CLOSE pulse times and pulse voltages as these are already preset. The following is a conceptual diagram of the output waveform (not the actual output waveform).

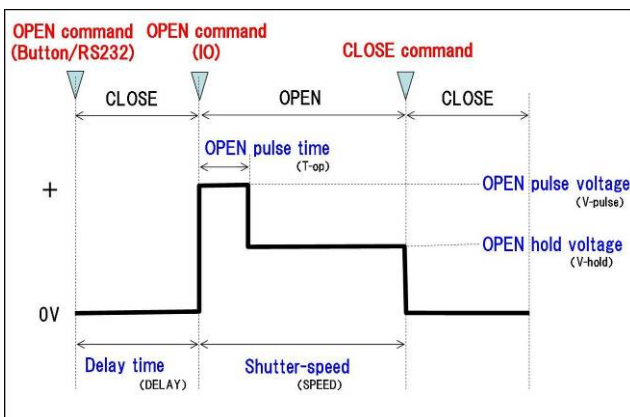

Fig. 3-3(a) Output waveform of TYPE-A

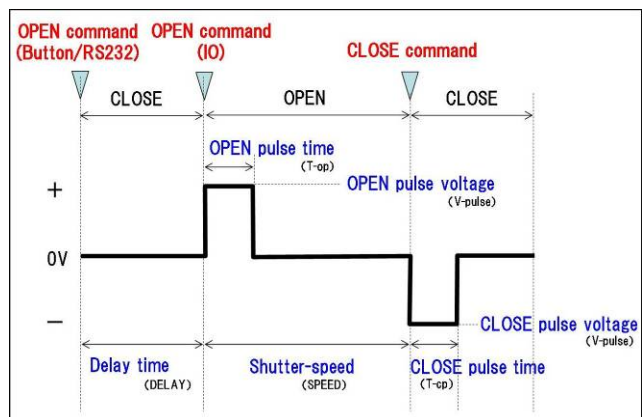

Fig. 3-3(b) Output waveform of TYPE-B

3-2-2 Additional Procedures of Shutter Type

The following shows the steps to add a new shutter to register to CH1.

1. Basic screen

	N	O	N	E					N	O	N	E				
		-	-							-	-					

PUSH

 ×1 : Setup screen is displayed when the knob is pressed.

2. Setup screen

		C	H	1					M	O	D	E				
									B	U	L	B				

TURN

 : You can change the menu by turning the knob.

3. Display of USERDEF menu

	U	S	E	R	D	E	F												
▶																			▼

TURN

 ×22 : Set to USERDEF menu.

PUSH

 ×1 : Switch to sub menu by pressing the knob for USERDEF.

4. Enter name

	u	s	e	r	1			N	A	M	E								
▶								S	A	M	P	L	E	*					

PUSH

 : Press the knob to switch to the changing display. The value is flashing during the change.

During the change, the position is moved by pressing the knob. When the flashing is stop, the change is completed.

TURN

 : Shutter name up to 7 characters can be set up. " * " is blank, letters A -Z (capital letter), digits 0 to 9, underscore (_), hyphen (" - ") to be set. Sub-menu item can be changed by turning the knob when USER1、USER2、USER3 values are not flashing.

5. Input of OPEN pulse time

	u	s	e	r	1			T	-	o	p								
▶		(m	s)			0	2	0	.	0							

TURN

 ×1 : Set to T-op. menu of user1

PUSH

 : Press the knob to switch to the changing display. The value is flashing during the change. During the change, the position is moved by pressing the knob. When the flashing is stop, the change is completed.

TURN

 : The number can be increased and decreased. When the value is not flashing, the sub-menu item can be changed turning the knob.

6. Input of CLOSE pulse time (TYPE-A shutter is Optional)

	u	s	e	r	1			T	-	c	p								
▶		(m	s)			0	2	0	.	0							

TURN

 ×1 : Set to T-cp. menu of user1

PUSH

 : Press the knob to switch to the changing display. The value is flashing during the change. During the change, the position is moved by pressing the knob. When the flashing is stop, the change is completed.

TURN

 : The number can be increased and decreased. When the value is not flashing, the sub-menu item can be changed turning the knob.

7. Input of pulse voltage

	u	s	e	r	1		V	-	p	u	l	s	e
E		(V)			1	2					

 $\times 1$: Set to V-pulse menu of user1

 : Press the knob to switch to the changing display. The value is flashing during the change. During the change, the position is moved by pressing the knob. When the flashing is stop, the change is completed.

 : The number can be increased and decreased. When the value is not flashing, the sub-menu item can be changed turning the knob.

8. Input of hold voltage
(TYPE-B shutter is Optional)

	u	s	e	r	1		V	-	h	o	l	d	
E		(V)			0	8					

 $\times 1$: Set to V-hold menu of user1

 : Press the knob to switch to the changing display. The value is flashing during the change. During the change, the position is moved by pressing the knob. When the flashing is stop, the change is completed.

 : The number can be increased and decreased. When the value is not flashing, the sub-menu item can be changed turning the knob.

9. Selection of shutter type

	u	s	e	r	1		T	Y	P	E			
E							T	Y	P	E	-	A	

 $\times 1$: Set to TYPE menu of user1.

 : Press the knob to switch to the changing display. The value is flashing during the change. The value is determined by pressing the knob again.

 : The number can be increased and decreased. When the value is not flashing, the sub-menu item can be changed by turning the knob.

10. Return to setup screen

	R	E	T	U	R	N							
E													

 $\times 13$: Set to RETURN menu.
(far right side of the menu).

 $\times 1$: Press the knob to return to the setup screen.

11. Display of shutter selection menu

			C	H	I					M	O	D	E	L			
E										N	O	N	E				

TURN

 ×16 : The change of the displaying menu by turning the knob.

PUSH

 ×1 : The shutter model can be changed by pressing the knob.

Values are flashing during the change.

12. Selection of shutter type

			C	H	I					M	O	D	E	L			
E										S	A	M	P	L	E	*	

TURN

 : Selection of the shutter type is added.

PUSH

 ×1 : The value is determined by pressing the knob.

13. Save of setting

			E	X	I	T										
										<	P	U	S	H	>	

TURN

 ×18 : Set to EXIT menu. (Far right side of the menu)

PUSH

 ×1 : The Exit menu is displayed by pressing the knob.

Cursor

			S	A	V	E	?			▶	C	A	N	C	E	L	
E			Y	E	S						N	O					

TURN

 ×1 : Move the cursor to YES.

PUSH

 ×1 : Settings are saved by pressing the knob, return to the Basic screen.



※ Select the CANCEL if you undo the setting, or select the NO if you do not want to save.

14. Basic screen

			S	A	M	P	L	E			N	O	N	E			
			c	l	o	s	e				-	-					

3-2-2 Sub-menu of User-defined (USERDEF)

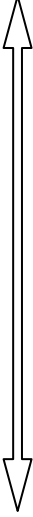
Table 3-1 Sub-menu of user-defined (USERDEF)

SW	No.	Name	Details	Setting value	Default value
Left 	1	user1 NAME	Setting of user1 name	※1	*****
	2	user1 T-op	OPEN pulse time of user1	0.1ms~999.9ms	10ms
	3	user1 T-cp	CLOSE pulse time of user1	0.1ms~999.9ms ※2	10ms
	4	user1 V-pulse	OPEN pulse voltage of user1	5V~24V	5V
	5	user1 V-hold	OPEN hold voltage of user1	5V~24V ※3	5V
	6	user1 TYPE	Selection of user1 shutter type.	TYPE-A / TYPE-B	TYPE-A
	7	user2 NAME	Setting of user2 name	※1	*****
	8	user2 T-op	OPEN pulse time of user2	0.1ms~999.9ms	10ms
	9	user2 T-cp	CLOSE pulse time of user2	0.1ms~999.9ms ※2	10ms
	10	user2 V-pulse	OPEN pulse voltage of user2	5V~24V	5V
	11	user2 V-hold	OPEN hold voltage of user2	5V~24V ※3	5V
	12	user2 TYPE	Selection of user2 shutter type.	TYPE-A / TYPE-B	TYPE-A
	13	user3 NAME	Setting of user3 name	※1	*****
	14	user3 T-op	OPEN pulse time of user3	0.1ms~999.9ms	10ms
	15	user3 T-cp	CLOSE pulse time of user3	0.1ms~999.9ms ※2	10ms
	16	user3 V-pulse	OPEN pulse voltage of user3	5V~24V	5V
	17	user3 V-hold	OPEN hold voltage of user3	5V~24V ※3	5V
	18	user3 TYPE	Selection of user3 shutter type.	TYPE-A / TYPE-B	TYPE-A
Right 	19	RETURN	Transition to setup menu by press knob	▲  Please refer to Section 2-2-3 for more information	-

- ※ 1. The shutter name up to 7 characters can be set up. " * " is blank, letters A -Z (capital letter), digits 0 to 9, underscore (_), hyphen (" - ") to be set.
- ※ 2. CLOSE pulse will be output if shutter type is TYPE-B.
- ※ 3. OPEN hold voltage will be output if shutter type is TYPE-A.
OPEN hold voltage can not be set higher than OPEN pulse voltage.

3-3 Shutter Control by External Input

3-3-1 GATE Mode

GATE is a method for opening the shutter while the external control signal is on.

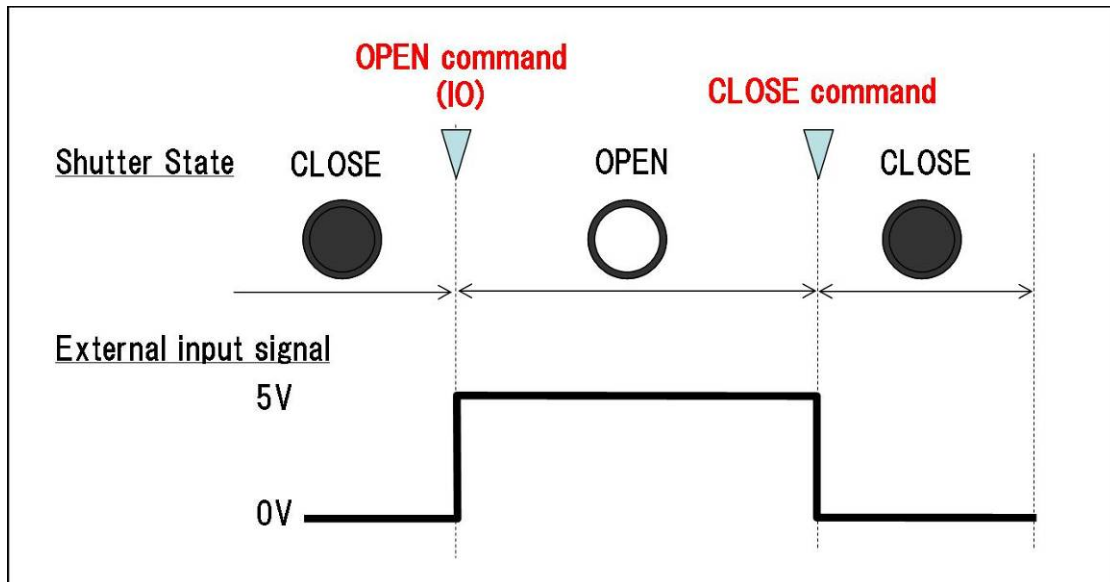

Fig.3-4 GATE mode (Active High)

3-3-2 TRIGGER Mode

TRIGGER is when the external control signal changes, a point when the shutter opens, and consequently starts the timer. This is way for closing the shutter after a set time has elapsed.

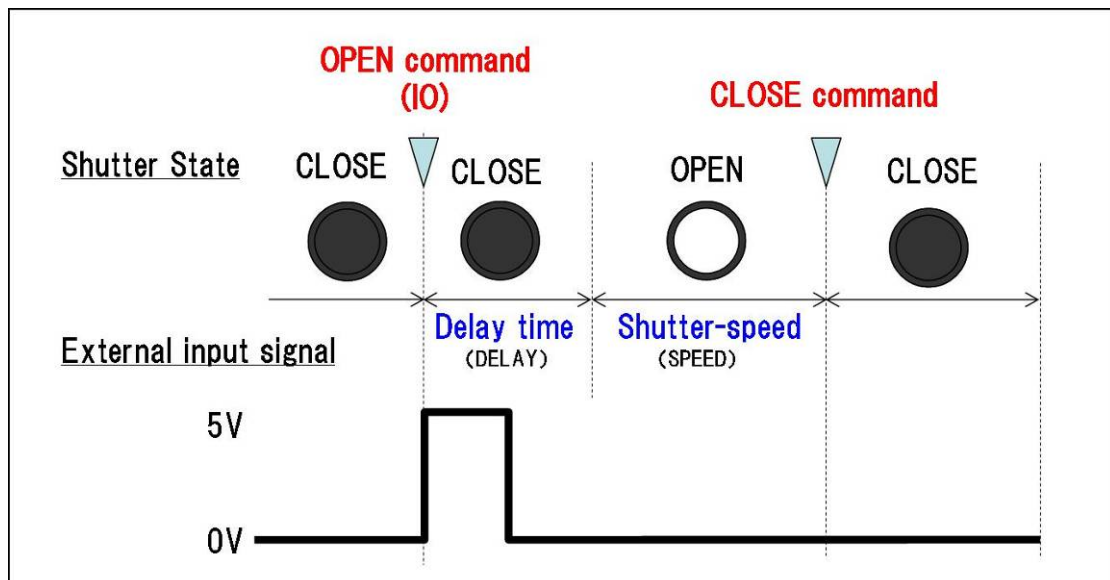

Fig.3-3 TRIGGER mode

3-3-3 Polarity of External Control Signal

This product, by way of the external control signal, can drive the shutter. Active Low, a method for opening the shutter, is when the external control signal is at 0V; the shutter closes when the external control signal is at 5V. Active High, a method for opening the shutter, is when the external control signal is at 5V; the shutter closes at 0V.

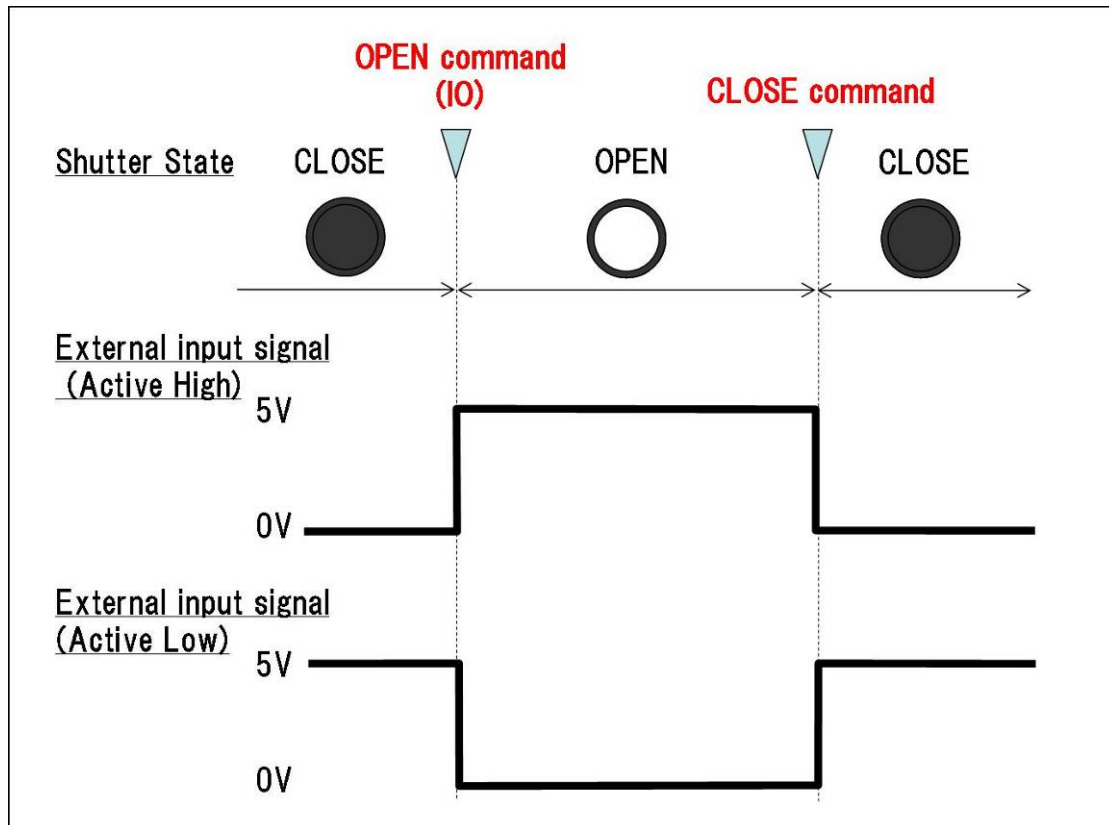

Fig.3-6 Active High / Active Low

Chapter 4 Serial Communication

This product can do serial communications with RS-232C and USB. It can also be compatible with the old product (SSH-C4B). The two command structure between the old SSH-C4B and this new SSH-C2B can be used by switching. The command structure can be switched to SSH-C2B/SSH-C4B common command or to the set screen of the front panel. In case of using SSH-C4B demonstration program, please use after the set change of this unit. In addition, please use a straight-through cable to connect to a computer.

▪ Communications parameter	Baud rate	9600/ 19200/ 38400bps
	Data bit	8bit
	Parity	None
	Stop bit	1bit
	Flow control	RTS/CTS
	Delimiters	CR+LF

4-1 SSH-C2B / SSH-C4B Common Commands

The following is the command command of SSH-C2B and SSH-C4B. It is used when the command structure is switched.

Table 4-1 SSH-C2B / SSH-C4B Common Commands

Command	Operation	Parameter	Return			Save Setting Value
SC	Selecting Command Structure	<mode>='1': New Command Structure '2': Old Command Structure (SSH-C4BCompatible)	Normal	S (in case of C2B) A (in case of C4B)	OK	○
			Error	C, P, B (in case of C2B) F, B (in case of C4B)		×
GC	Reading Command Structure	None	Normal	S□<mode> (in case of C2B) A□<mode> (in case of C4B)	<mode> refer to SC command parameter	-
			Error	C, P, B (in case of C2B) F, B (in case of C4B)		

Selecting Command Structure

Command	"SC"
Parameter	'<mode>'
Return	SSH-C2B Command Structure
	'S' Successful completion
	'P' Parameter error
	'C' Command error
	'B' BUSY error

SSH-C4B Command Structure

'A' Successful completion
 'B' Parameter error
 'F' Command (Error for No Execution)

Explanation Selecting Command Structure

<mode>= '1' New Command Structure(SSH-C2Bcommand Only)
 '2' Old Command Structure (SSH-C4B compatible command)

Example (Sending) SC□1 (CR)(LF) Selecting New Command Structure
 (Returning)

Reading Command Structure

Command "GC"
 Parameter None
 Return SSH-C2B Command Structure
 "S□<mode>" Successful completion
 'P' Parameter error
 'C' Command error

SSH-C4B Command Structure

"A□<mode>" Successful completion
 'B' Parameter error

Explanation Getting the Command Structure to be set

(Returning) mode>= '1' New Command Structure (SSH-C2B command only)
 '2' Old Command Structure (SSH-C4B compatible command)

Example (Sending) GC(CR)(LF) Asking new current Command Structure, and selecting
 (Returning) A□1(CR)(LF)

4-2 SSH-C2B Command

4-2-1 Description

The following rules are applied.

- Single quotes (') is a single character.
- Double quotes (") is the string (multiple-characters).
- <> is a parameter with more than one character.
- □ is a space character.

4-2-2 Protocol

SSH-C2B command mode consists of the basic protocol with the following two types of packets.

1. Command packet
2. Return packet

Packet is configured as the string with the delimited CR code and LF code at the end. Each string consists of the capitals of alphanumeric characters.

The basic of the protocol is to send the command packet from the external device to this product, and to send the return packet from this product to the external device with the answer. The command packet and the return packet are one-to-one correspondences. The external device must receive the reply in case of sending a command to this product.

4-2-2-1 Command Packet

The command packet format is shown as below.



- ①Command The Command string consisting of ASCII English characters and command identification symbol (「:」or「?」)
- ②Parameter The parameter string. Required parameters are listed. When the command identification symbol is 「:」 (set command), the parameter is required. When the command identification symbol is 「?」 (acquisition command), the parameter is not required.
- ③Delimiter The delimiter string consisting of CR code and LF code.

4-2-2-2 Return Packet

The return packet format is shown as below.

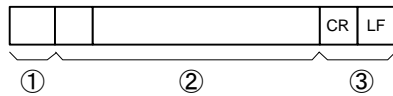

- ①Return Code Result of the command execution is returned.
- ②Return Parameter It is added by a command. Return code and return parameter are separated by space characters.
- ③Delimiter Delimiter string consisting of CR code and LF code.

The return code, which is returning to return packet, has the following 4 types.

'S'	Successful completion
'C'	Command error
'P'	Parameter error
'B'	BUSY error

- In case of sending a command, which is not in the list, or sending a command character by a mistake, it is the command error (C).
- In case of out of the specified range of the parameter, it is the parameter error (P).
- Parameter must be separated only by comma (,). In case of being specified by other than the comma, it is the parameter error (P).
- During the interlock condition and the shutter control, if the operation command or the set command is sent, it is the BUSY error (B).
- Reading the set value is also available during shutter's working .
- The command mode in SSH-C 2B does not have the function of the interrupt packet of command mode in SSH-C4B.

4-2-3 Command List

Classification of SSH-C2B command group: ① for channel, ② for parameter set, ③ system setting.

Table 4-2 Command group for channels

Command	Operating	Parameter	Return			Save Value
OPEN:	Set shutter opening	<ch> '1': CH1 '2': CH2	Normal	S	OK	-
			Error	C, P or B		
OPEN?	Reading shutter open/close status	<ch> '1': CH1 '2': CH2	Normal	S□<ch>,<status>,<rep>	<status> 'O': OPEN 'C': CLOSE <rep> Operating: numbers of stop repeats Stopping: numbers of set repeats (other parameters are OPEN: Refereed to Command)	-
			Error	C or P		
CLOSE:	Set shutter closing	<ch> '1': CH1 '2': CH2	Normal	S	OK	-
			Error	C, P or B		
CNT:	Reset integrated values of shutter open/close	<ch> '1': CH1 '2': CH2	Normal	S	OK (Resetting the counter)	○
			Error	C, P or B		-
CNT?	Reading integrated values of shutter open/close	<ch> '1': CH1 '2': CH2	Normal	S□<ch>,<count>	<count> Current value of the counter (the other parameters are CNT: refer to command parameter).	-
			Error	C or P		
DLY:	Set delay time	<ch>,<delay> <ch> '1': CH1 '2': CH2 <delay> Delay time	Normal	S	OK	○
			Error	C, P or B		×
DLY?	Reading delay time	<ch> '1': CH1 '2': CH2	Normal	S□<ch>,<delay>	DLY:refer to command parameter	-
			Error	C or P		
MODE:	Set shutter mode	<ch>,<mode> <ch> '1': CH1 '2': CH2 <mode> 'T' Timer 'B' BULB	Normal	S	OK	○
			Error	C, P or B		×
MODE?	Reading shutter mode	<ch> '1': CH1 '2': CH2	Normal	S□<ch>,<mode>	MODE:refer to command parameter	-
			Error	C or P		
REPF:	Set repeat frequency	<ch>,<freq> <ch> '1': CH1 '2': CH2 <freq> Repeat frequency	Normal	S	OK	○
			Error	C, P or B		×

REPF?	Reading repeat frequency	<ch> '1': CH1 '2': CH2	Normal	S□<ch>,<freq>	REPF:refer to command parameter	-
			Error	C or P		
REPT:	Set number of repeats	<ch>,<count> <ch> '1': CH1 '2': CH2 <count> number of repeats	Normal	S	OK	○
			Error	C、P or B		×
REPT?	Reading number of repeats	<ch> <ch> '1': CH1 '2': CH2	Normal	S□<ch>,<count>	REPT:refer to command parameter	-
			Error	C or P		
SPD:	Set shutter speed	<ch>,<speed> <ch> '1': CH1 '2': CH2 <speed> Speed value(ms/s/Hz ∅ Including unit character)	Normal	S	OK	○
			Error	C、P or B		×
SPD?	Reading shutter speed	<ch> '1': CH1 '2': CH2	Normal	S□<ch>,<speed>	SPD:refer to command parameter	-
			Error	C or P		

Shutter OPEN Control

Command "OPEN:"

Parameter "<ch>"

Return 'S' Successful completion
'C' Command error
'P' Parameter error
'B' BUSY error

Explanation Conduct the control for the specified CH OPEN
<ch> CH number Specify '1'or'2'

Attention: When the shutter is closed, the shutter is open in this command. The controller of the shutter replies after the completion of the opening of the shutter. When the shutter is open at the "OPEN:" command, please close at the "CLOSE: "command. It will not be closed in the IO or button.

Example (Sending) OPEN:1 (CR)(LF) Open CH1
(Returning) S (CR)(LF) Successful completion

Reading Shutter Open/Close Status

Command	"OPEN?"		
Parameter	"<ch>"		
Return	"S□<ch>,<status>,<repeat>"	Successful completion	
	'C'	Command error	
	'P'	Parameter error	
Explanation	Returning open/close status of the specified CH		
	(Sending) <ch> CH number	Specify '1' or '2'	
	(Returning) <ch> CH number	'1' or '2'	
	<status> Open/Close Status	'C' close status	
		'O' open status	
	<repeat> number of repeat	'0' No repeat	
		'0' other than	Current number of repeat (open status)
			Number of repeat set (close status)

Attention: In case of operating by external input signal, the number of operation is returned to repeat.

Example	(Sending) OPEN?1(CR)(LF)	Asking the open/close status of CH1
	(Returning) S□1,O,2(CR)(LF)	Repeating 2 times in the open status of CH1

Shutter Close Control

Command	"CLOSE:"	
Parameter	"<ch>"	
Return	'S'	Successful completion
	'C'	Command error
	'P'	Parameter error
	'B'	BUSY error

Explanation	Conduct the control for the specified CH OPEN	
	<ch>	CH number Specify '1' or '2'

Attention: When the shutter is open, the shutter is closed in this command. The controller of the shutter replies after the completion of the closing of the shutter. When the shutter is open in the IO or the button, although this command is activated, the BUSY error happens and the shutter will not be able to close. When you want to use, please check the current shutter status in the reading command of the shutter status.

Example	(Sending) CLOSE:1(CR)(LF)	Close CH1
	(Returning)	Successful completion

Reset Integrated Value of Shutter Open/Close

Command	"CNT:"	
Parameter	'<ch>'	
Return	'S'	Successful completion
	'C'	Command error
	'P'	Parameter error
	'B'	BUSY error

Explanation Resetting the integrated value of CH's shutter open/close

Attention During the operation of the shutter, it results in the error that the command execution is not allowed

Example	(Sending) CNT:1(CR)(LF)	Resetting the integrated value of CH1
	(Returning) S(CR)(LF)	Successful completion

Reading Integrated Value of Shutter Open/Close

Command	"CNT?"	
Parameter	'<ch>'	
Return	"S□<ch>,<count>"	Successful completion
	'C'	Command error
	'P'	Parameter error

Explanation Getting the integrated value of shutter open/close at each CH.

Example	(Sending) CNT?1(CR)(LF)	Asking the integrated value of CH1
	(Returning) S□1,123456(CR)(LF)	Integrated value of CH1 is returned

Setting Delay Time

Command	"DLY:"	
Parameter	"<ch>,<delay>"	
Return	'S'	Successful completion
	'C'	Command error
	'P'	Parameter error
	'B'	BUSY error

Explanation Setting specified CH's delay time. The delay time is the waiting time from receiving of the shutter open command until sending actual open pulse to the shutter. The delay time is valid in the timer mode (Command, button) 。 It is invalid in the BULB mode (Command, button) or in the IO control.

<ch>	CH number	'1'or'2' specifying
<delay>	Delay time	"0.0" no delay "0.1"~"999.9"(ms units) setting delay time

Attention: It can be omitted in case that the decimal place is zero (0)

Example (Sending) DLY:1,100.0(CR)(LF) Setting 100.0ms for CH's delay time
(Returning) S(CR)(LF) Successful completion

Reading Delay Time

Command	"DLY?"	
Parameter	'<ch>'	
Return	"S□<ch>,<delay>"	Successful completion
	'C'	Command error
	'P'	Parameter error

Explanation Setting the number of repeat of the specified CH

(Sending)	<ch>	CH number	'1'or'2' specifying
(Returning)	<ch>	CH number	'1'or'2'
	<delay>	Delay time	"0.0" No delay "0.1"~"999.9"(ms units) setting delay time

Example (Sending) DLY?1 (CR)(LF) Asking delay time of CH1
(Returning) S□1,100.0 (CR)(LF) Current set value is returned

Setting Shutter Mode

Command	"MODE:"		
Parameter	"<ch>,<mode>"		
Return	'S'	Successful completion	
	'C'	Command error	
	'P'	Parameter error	
	'B'	BUSY error	
Explanation	Setting the specified CH's mode		
	<ch>	CH number	'1'or'2' specifying
	<mode>	Mode	'T' Timer mode
			'B' BULB mode

Attention This mode is to set the operating mode when it is controlled by the command or the button. In case of the BULB mode, it is open in the "OPEN:"command" and it is closed in the "CLOSE:" command. If the set time is passed in the timer mode, it is closed automatically. In case of controlled by IO, please set by IO: command.

Example	(Sending) MODE:1,T(CR)(LF)	Setting CH1 in the timer mode
	(Returning) S(CR)(LF)	Successful completion

Reading Shutter Mode

Command	"MODE?"		
Parameter	"<ch>"		
Return	'S□<ch>,<mode>'	Successful completion	
	'C'	Command error	
	'P'	Parameter error	
Explanation	getting the specified CH's mode		
	(Receiving)<ch>	CH number	Specify '1'or'2'
	<mode>	mode	'T' timer mode
			'B' BULB mode

Example	(Sending) MODE?1(CR)(LF)	Getting the mode set as CH1
	(Returning) S□1,T(CR)(LF)	Set value is returned

Setting Repeat Frequency

Command	"REPF:"	
Parameter	"<ch>,<freq>"	
Return	'S'	Successful completion
	'C'	Command error
	'P'	Parameter error
	'B'	BUSY error

Explanation Setting the repeat frequency of CH

<ch>	CH number	Specify '1'or'2'
<freq>	Repeat Frequency (Hz)	Repeat frequency "0.1"~"500.0"

Attention Repeat is valid when you set up 2 or more times in the REPT:command. It can be omitted in case that the decimal place is zero(0). The time to be set must be met by the following formula.

Repeat time (sec) = 1/repeat frequency (Hz)

Repeat time >= delay time + shutter speed (time)+(CLOSE pulse time)

※ CLOSE pulse time will be calculated in case of TYPE-B shutter.

In case of setting shutter speed by 10 sec or more, the number of repeat will be automatically one (1), the repeat can not be done.

Example (Sending) REPF:1,100.0(CR)(LF) Setting the repeat frequency of CH1 to 100Hz
(Returning) S(CR)(LF) Successful completion

Reading Repeat Frequency

Command "REPF?"
 Parameter "<ch>,<freq>"
 Return "S□<ch>,<freq>" Successful completion
 'C' Command error
 'P' Parameter error

Explanation Setting the repeat frequency of the specified CH
 <ch> CH number Specify '1'or'2'
 <freq> Repeat frequency (Hz) Repeat frequency "0.1"~"500.0"

Attention It can be omitted in case that as the decimal place is zero (0).

Example (Sending) REPF?1 (CR)(LF) Asking the repeat frequency of CH1
 (Returning) S□1,100.0(CR)(LF) Set value is returning

Setting of the Number of Repeat

Command "REPT:"
 Parameter "<ch>,<count>"
 Return 'S' Successful completion
 'C' Command error
 'P' Parameter error
 'B' BUSY error

Explanation Setting the number of repeat of the specified CH
 <ch> CH number Specify '1'or'2'
 <count> Repeat Frequency '1' No repeat
 '2'~"999999" Number of repeat

Attention In case of setting shutter speed by 10 sec or more, the number of repeat will be automatically one (1).

Example (Sending) REPT:1,100(CR)(LF) Setting the repeat number of CH1 to 100
 (Returning) S(CR)(LF) Successful completion

Getting Number of Repeat

Command	"REPT?"	
Parameter	'<ch>'	
Return	"S□<ch>,<count>"	Successful completion
	'C'	Command error
	'P'	Parameter error

Explanation Setting the number of repeat of the specified CH

(Sending)	<ch>	CH number	Specify '1'or'2'
(Returning)	<ch>	CH number	'1or'2'
	<count>	number of repeat	'1' No repeat '2'~"999999" number of repeat

Example (Sending) REPT?1 (CR)(LF) Asking the number of repeat of CH1
 (Returning) S□1,100(CR)(LF) Number of repeat, which was set, is returned

Setting Shutter Speed

Command	"SPD:"
Parameter	"<ch>,<speed>"
Return	'S' Successful completion
	'C' Command error
	'P' Parameter error
	'B' BUSY error

Explanation Setting parameter related to the specified CH

<ch>	CH number	Specify '1' or '2'
<speed>	Shutter Speed	Setting by number and unit string (ms/s/Hz) Numerical range that can be set by units is different
ms	when setting units	: 0.1~99999.9 (ms)
s	when setting units	: 1~99999 (s)
Hz	when setting units	: 1~100000 (Hz) ...1s~0.1ms equivalence

Attention User can set by adding units in order for easy-to-understand. When using ms unit, it can be omitted in case that the decimal place is zero (0). The shutter speed value must be met by the following formula.

$$\text{Shutter speed (time)} \geq \text{OPEN pulse time}$$

In case that the shutter speed is 10 sec or more, the repeat can not be set. (the number of repeat will be automatically one (1)). This value can be saved by 0.1ms unit internally. Thus, if you switch to other unit, the rounding and truncation for numerical value may occur.

Example (Sending) SPD:1,100.5ms(CR)(LF) Setting the shutter speed of CH1 to 100.5ms
(Returning) S(CR)(LF) Successful completion

Getting Shutter Speed

Command	"SPD?"	
Parameter	'<ch>'	
Return	"S□<speed>"	Successful completion
	'C'	Command error
	'P'	Parameter error

Explanation	Setting the parameter set by CH	
(Sending) <ch>	CH number	Specify '1' or '2'
(Returning) <ch>	CH number	'1' or '2'
<speed>	Shutter speed	The unit that was set is returned

Example (Sending) SPD:1 (CR)(LF) Asking the shutter speed of CH1
(Returning) S□1,100hz (CR)(LF) Set value of 100Hz is returned

Table 4-3 Command group for parameter setting

Command	Operation	Parameter	Return			Save Value
NAME:	Setting Shutter Name (For user-defined)	<no>,"<name>" <no> '5' ~'7' User-defined (USER1~USER3) <name> Shutter Name Maximum 7 characters	Normal	S	OK	○
			Error	C, P or B		×
NAME?	Reading Shutter Name	<no> '1'~'4' Preset '5'~'7' User-defined	Normal	S□<no>,"<name>"	NAME:refer to command parameter	-
			Error	C or P		
SEL:	Selecting Parameter Set	<ch>,<no> <ch> '1': CH1 '2': CH2 <no> '0' "NONE" '1'~'4' Preset '5'~'7' User-defined	Normal	S	OK	○
			Error	C, P or B		×
SEL?	Getting Parameter Set	<ch> '1': CH1 '2': CH2	Normal	S□<ch>,<no>	SEL:refer to command parameter	-
			Error	C or P		
TIME:	Setting Pulse Time (Timing) (For user-defined)	<no>,<Top>,<Tcp> <no> '5'~'7' User-defined <Top> OPEN pulse time <Tcp> CLOSE pulse time	Normal	S	OK	○
			Error	C, P or B		×
TIME?	Reading Pulse Time (For user-defined)	<no> '5'~'7' User-defined	Normal	S□<no>,<Top>,<Tcp>	TIME:refer to command parameter	-
			Error	C or P		
TYPE:	Selecting Shutter Type (For user-defined)	<no>,<type> <no> '5'~'7' User-defined <type> 'A': TYPE-A 'B': TYPE-B	Normal	S	OK	○
			Error	C, P or B		×
TYPE?	Reading Shutter Type (For user-defined)	<no> '1'~'4' Preset '5'~'7' User-defined	Normal	S□<no>,<type>	TYPE:refer to command parameter	-
			Error	C or P		
VOLT:	Setting Voltage (For user-defined)	<no>,<V-pulse>,<V-hold> <no> '5'~'7' User-defined <V-pulse> Pulse voltage <V-hold> OPEN hold voltage	Normal	S	OK	○
			Error	C, P or B		×
VOLT?	Reading Voltage (For user-defined)	<no> '5'~'7' User-defined	Normal	S□<no>,<V-pulse>,<V-hold>	VOLT:refer to command parameter	-
			Error	C or P		

Setting Shutter Name (User-defined)

Command	"NAME:"	
Parameter	"<no>,"<name>" "	
Return	'S'	Successful completion
	'C'	Command error
	'P'	Parameter error
	'B'	BUSY error

Explanation	Set the name in the set of User-defined parameter of the specified number	
<no>	Shutter's number	Specify '5'~'7' (Corresponding to USER1 ~ USER3)
"<name>"	name	Set up to 7 characters

Attention <name> should be in double quotes ("). If you do not have 7 characters, the rest part will be replaced by space characters. In case that all 7 characters are blank or there are no specified characters, all characters are set to be blank (shipping status at factory). In this case, please be careful that SEL:command channel can not be set. The available characters are English letter (capital), numbers, underscore(_), and hyphen(-). As parameter set 1 to 3 is Preset defined, the name cannot be changed. If you do not want to set the User-defined to channel(not appear in the list), please set the User-defined name(NAME:command) by "□□□□□□□" (7 characters with the blank characters).

Example	(Sending) NAME:5,"SAMPLE1"(CR)(LF)	Specify 「SAMPLE1」 as the name of USER1
	(Receiving) S(CR)(LF)	Successful completion

Reading Shutter Name

Command	"NAME?"	
Parameter	'<no>'	
Return	"S□<no>,"<name>" "	Successful completion
	'C'	Command error
	'P'	Parameter error

Reading Shutter Set

Command	"SEL?"
Parameter	"<ch>"
Return	"S□<ch>,<no>" Successful completion
	'C' Command error
	'P' Parameter error

Explanation	Getting parameter set to be set to CH		
(Sending) <ch>	CH number		Specify '1'or'2'
(Returning) <ch>	CH number		'1' or '2'
	<no>	Set number	'0' 「NONE」
			'1' 「SSH-R」
			'2' 「SSH-S」
			'3' 「SHPS」
			'4' 「SSH25RA」
			'5'~'7' USER1~USER3

Example	(Sending)	SEL?1(CR)(LF)	Asking parameter set to be set to CH1
	(Returning)	S□1,2(CR)(LF)	"SSH-S" is set to CH1.

Setting Time(Timing) (User-defined)

Command	"TIME:"
Parameter	"<no>,<Top>,<Tcp>"
Return	'S' Successful completion
	'C' Command error
	'P' Parameter error
	'B' BUSY error

Explanation Setting open pulse time and close pulse time responding to the set of the User-defined parameter.

<no>	Set number	Specify '5'~'7' (Corresponding to USER1 ~ USER3)
<Top>	Open pulse time	Specify "0.1"~"999.9" (ms unit)
<Tcp>	Close pulse time	Specify "0.1"~"999.9" (ms unit)

Attention If the pulse time is set to use shorter than specifications of the shutter type, the shutter cannot be working correctly. It can be omitted if decimal place is zero (0).

Example	(Sending) TIME:5,100.0,50.0(CR)(LF)	Setting USER1 open pulse time to 100.0ms and user-defined1 close pulse time to 50.0ms
	(Returning) S(CR)(LF)	Successful completion

Reading Time (Timing)

Command	"TIME?"	
Parameter	'<no>'	
Return	"S□<no>,<Top>,<Tcp>"	Successful completion
	'C'	Command error
	'P'	Parameter error

Explanation Getting open pulse time and close pulse time (ms unit) as the set of the specified parameter.

(Sending) <no>	Set number	'5'~'7' (Corresponding to USER1 ~ USER3)
(Returning) <no>	Set number	As same above
<Top>	Open pulse time	Getting open pulse time
<Tcp>	Close pulse time	Getting close pulse time

Example	(Sending) TIME?5 (CR)(LF)	Asking the time of User-defined1 setting
	(Returning) S□5,100.0,50.0 (CR)(LF)	Set value is returned

Selecting Shutter Type (User-defined)

Command	"TYPE:"	
Parameter	"<no>,<type>"	
Return	'S'	Successful completion
	'C'	Command error
	'P'	Parameter error
	'B'	BUSY error

Explanation Setting the shutter type responding to the set of User-defined parameter

<no>	Set number	Specify '5'~'7' (Corresponding to USER1 ~ USER3)
<type>	Shutter Type	Selecting 'A' TYPE-A shutter Selecting 'B' TYPE-B shutter

Example	(Sending) TYPE:5,A(CR)(LF)	Setting 「TYPE-A」 to USER1
	(Returning) S(CR)(LF)	Successful completion

Reading Shutter Type

Command	"TYPE?"	
Parameter	"<no>"	
Return	'S□<no>,<type>'	Successful completion
	'C'	Command error
	'P'	Parameter error
Explanation	Getting the shutter type to be set to the set of the specified parameter	
	<no> Set number	'1'~'4' (Preset)
		'5'~'7' (Corresponding to USER1 ~ USER3)
	<type> Shutter type	'A' 「TYPE-A」 'B' 「TYPE-B」
Example	(Sending) TYPE?2(CR)(LF)	Asking the shutter type of the Set number 2
	(Returning) S□2,A(CR)(LF)	Shutter type 「TYPE-A」 is returned

Setting Voltage (User-defined)

Command	"VOLT:"	
Parameter	"<no>,<V-pulse>,<V-hold>"	
Return	'S'	Successful completion
	'C'	Command error
	'P'	Parameter error
	'B'	BUSY error
Explanation	Setting the pulse voltage and hold voltage responding to the set of User-defined parameter	
	<no> Set number	Specify '5'~'7' (Corresponding to USER1 ~ USER3)
	<V-pulse>Pulse voltage	Specify '5'~"24"
	<V-hold>Open hold voltage	Specify '5'~"24"

Attention The pulse voltage is the value of the open pulse voltage and the close pulse voltage. The open pulse voltage is a positive pulse and the close pulse voltage is a negative pulse. For example, when 「24」 is set to <V-pulse>, the open pulse voltage is 「+24V」 and the close pulse voltage is 「-24V」. In case of selecting TYPE-B shutter, <V-hold> cannot be used (hold time output is 0V) 。 In case of changing of the voltage of the shutter type, which was set to the channel, please use after 5 second waits. Sometimes the output voltage may be unstable. And, the following formula must be met.

$$\text{Pulse voltage V-pulse} \geq \text{Hold voltage V-hold}$$

Example (Sending) VOLT:5,24,5(CR)(LF) Setting 24V for the pulse voltage and 5V for the hold voltage of the USER1
(Returning) S(CR)(LF) Successful completion

Getting Voltage

Command "VOLT?"
Parameter '<no>'
Return "S□<no>,<V-pulse>,<V-hold>" Successful completion
'C' Command error
'P' Parameter error

Explanation Getting the voltage value that is set to the set of the specified parameter
(Sending) <no> Set number '5'~'7' (Corresponding to USER1 ~ USER3)
(Returning) <no> Set number As same above
<V-pulse > Pulse voltage '5'~"24"
<V-hold> Hold voltage '5'~"24"

Example (Sending) VOLT?5 (CR)(LF) Asking the voltage to be set by USER1
(Returning) S□5,24,5(CR)(LF) Pulse voltage "24V" and hold voltage "5 V" are returned

Table 4-4 Command group for system setting

Command	Operation	Parameter	Return			Save Value
STAT?	Reading Status	None	Normal	S□<interlock>, <ch1>, <ch2>	<interlock> '0': NORMAL '1': Interlocked <ch1> (<ch2>) CH1 (CH2) Status 'C': CLOSE 'O': OPEN	-
			Error	C or P		
VER?	Reading Version Number	None	Normal	S□<version>	version: Version string	-
			Error	C or P		
IO:	Setting IO Control	<mode>, <level> <mode>'T': Trigger Mode 'G': Gate Mode <level>'H': Active HIGH 'L': Active LOW	Normal	S	OK	○
			Error	C, P or B		×
IO?	Reading IO Control Setting	None	Normal	S□<mode>, <level>	IO: refer to command parameter	-
			Error	C or P		
LCD:	Setting LCD Back Light	<mode>'0': always OFF '1': always ON '5': 5seconds ON	Normal	S	OK	○
			Error	C, P or B		×
LCD?	Reading LCDBack Light Setting	None	Normal	S□<mode>	LCD: refer to command parameter	-
			Error	C or P		
LED:	Setting LED Light On /Off	<mode>'0': Light Off '1': Light On	Normal	S	OK	○
			Error	C, P or B		×
LED?	Reading LED Light On/Off	None	Normal	S□<mode>	LED: refer to command parameter	-
			Error	C or P		

Reading Controller Status

Command	"STAT?"	
Parameter	None	
Return	"S□<interlock>,<ch1>,<ch2>"	Successful completion
	'C'	Command error
	'P'	Parameter error

Explanation	Current operating status is returned	
	<interlock> Interlock status	'0' normal status '1' interlock status
	<ch1> Open/close status of CH1	'C' close status 'O' open status
	<ch2> Open/close status of CH2	As same as CH1

Attention This command does not need parameter. In case of sending with parameter string, parameter error will occur

Example	(Sending) STAT?(CR)(LF)	Asking
	(Returning) S□1,C,O(CR)(LF)	Interlock status、CH1(close), CH2(open)

Getting Firmware Version

Command	"VER?"	
Parameter	None	
Return	"S□<version>"	Successful completion
	'C'	Command error
	'P'	Parameter error

Explanation Asking firmware version

Example	(Sending) VER?(CR)(LF)	Asking version
	(Returning) S□V1.00,003(CR)(LF)	Version string is returned

Setting IO Control

Command	"IO:"	
Parameter	"<mode>,<level>"	
Return	'S'	Successful completion
	'C'	Command error
	'P'	Parameter error
	'B'	BUSY error

Explanation Setting IO control mode and operation polarity

<mode> Mode	'T'	Trigger Mode
	'G'	Gate Mode
<level> Active level	'H'	Active HIGH
	'L'	Active LOW

Attention After you switch to the active level, if there is no change in the input signal, the shutter does not work.

Example	(Sending) IO:G,H(CR)(LF)	Setting IO Control to Gate Mode/Active HIGH
	(Returning) S(CR)(LF)	Successful completion

Reading IO Control Setting

Command	"IO?"	
Parameter	None	
Return	"S□<mode>,<level>"	Successful completion
	'C'	Command error
	'P'	Parameter error

Explanation Getting the current IO control mode

(Returning) <mode>	'T'	Trigger Mode
	'G'	Gate Mode
<level>	'H'	Active HIGH
	'L'	Active LOW

Example	(Sending) IO?(CR)(LF)	Asking the current IO Control Setting
	(Returning) S□G,H(CR)(LF)	Setting is retrieved

Setting LCD Back Light

Command	"LCD:"	
Parameter	'<mode>'	
Return	'S'	Successful completion
	'C'	Command error
	'P'	Parameter error
	'B'	BUSY error

Explanation Setting the light on status of LCD Back Light

<mode> Mode setting	'0'	Always OFF
	'1'	Always ON
	'5'	5 seconds ON

Attention When “ 5 seconds ON ” is selected, the light is on during the operation time in the front panel, and when the operation is completed, the light is off after 5 seconds.

Example	(Sending) LCD:1(CR)(LF)	Setting Back Light as always ON
	(Returning) S(CR)(LF)	Successful completion

Reading LCD Back Light Setting

Command	"LCD?"	
Parameter	None	
Return	"S□<mode>"	Successful completion
	'C'	Command error
	'P'	Parameter error

Explanation Getting the Light On status of LCD Back Light

(Returning) <mode> Mode setting	'0'	LCD Back Light Always OFF
	'1'	LCD Back Light Always ON
	'5'	LCD Back Light 5seconds ON

Example	(Sending) LCD?(CR)(LF)	Asking Back Light Setting
	(Returning)(LF) LCD	Back Light Setting is returned

Setting Button LED

Command	"LED:"	
Parameter	'<mode>'	
Return	'S'	Successful completion
	'C'	Command error
	'P'	Parameter error
	'B'	BUSY error

Explanation Setting the Light On status of shutter button LED in case of shutter-open

<mode> Mode setting	'0'	Light Off
	'1'	Light On

Example	(Sending) LED:1(CR)(LF)	Setting shutter button LED to the Light On
	(Receiving) S(CR)(LF)	Successful completion

Reading Button LED Setting

Command	"LED?"	
Parameter	None	
Return	"S□<mode>"	Successful completion
	'P'	Parameter error

Explanation Getting the Light On status of LCDBack Light

(Returning) <mode> Mode setting	'0'	Light Off
	'1'	Light On

Example	(Sending) LED?(CR)(LF)	Asking the Light On of LED
	(Returning)(LF)	Setting of LCD Back Light is returned

4-3 SSH-C4B Compatible Command

This product can use the command of SSH-C4B as it is for SSH-C4B compatible command.

For the detailed commands, please refer to the User's Manual for SSH-C4B. However, please keep in mind that there are the following differences.

1. At the command to specify CH number (SH, SM etc.), CH 3 and CH4 are invalid.
It is not an error to be compatible. And, the status of CH3 and CH4 at the reading command of the controller status is always zero (0).
2. At the set command of the timer mode value (ST), the timer value cannot be set to zero (0).
As a result, the operation mode by this command is not switched to the BULB and the timer mode.
3. At the set command of the shutter operation mode (SM), the timer value when the mode is switched is not necessary to be set to zero (0).
4. At the reading command of the timer mode value (GT,) if the value is set 999.9 seconds or more, it returns to 9999 (999.9 seconds).
5. At the LED set command (SF), OFF can be only by the LED shutter button.

4-4 USB Driver Installation (Windows7)

The following is related to USB Driver Installation of Personal Computer (PC).

In this product (SSH-C2B), the USB Driver is working by using WindowsXP/ Windows 7 OS.

1. The power is on of the PC, and operating Windows7
2. Please download a driver file from our homepage to PC.
3. Connecting the cable between the PC and SSH-C2B
4. The power is on of SSH-C2B

The PC is recognized and the following messages are displayed.

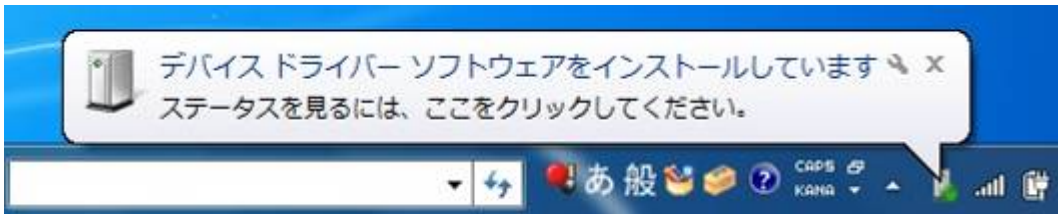

5. If the installation did not complete, Open Device Manager

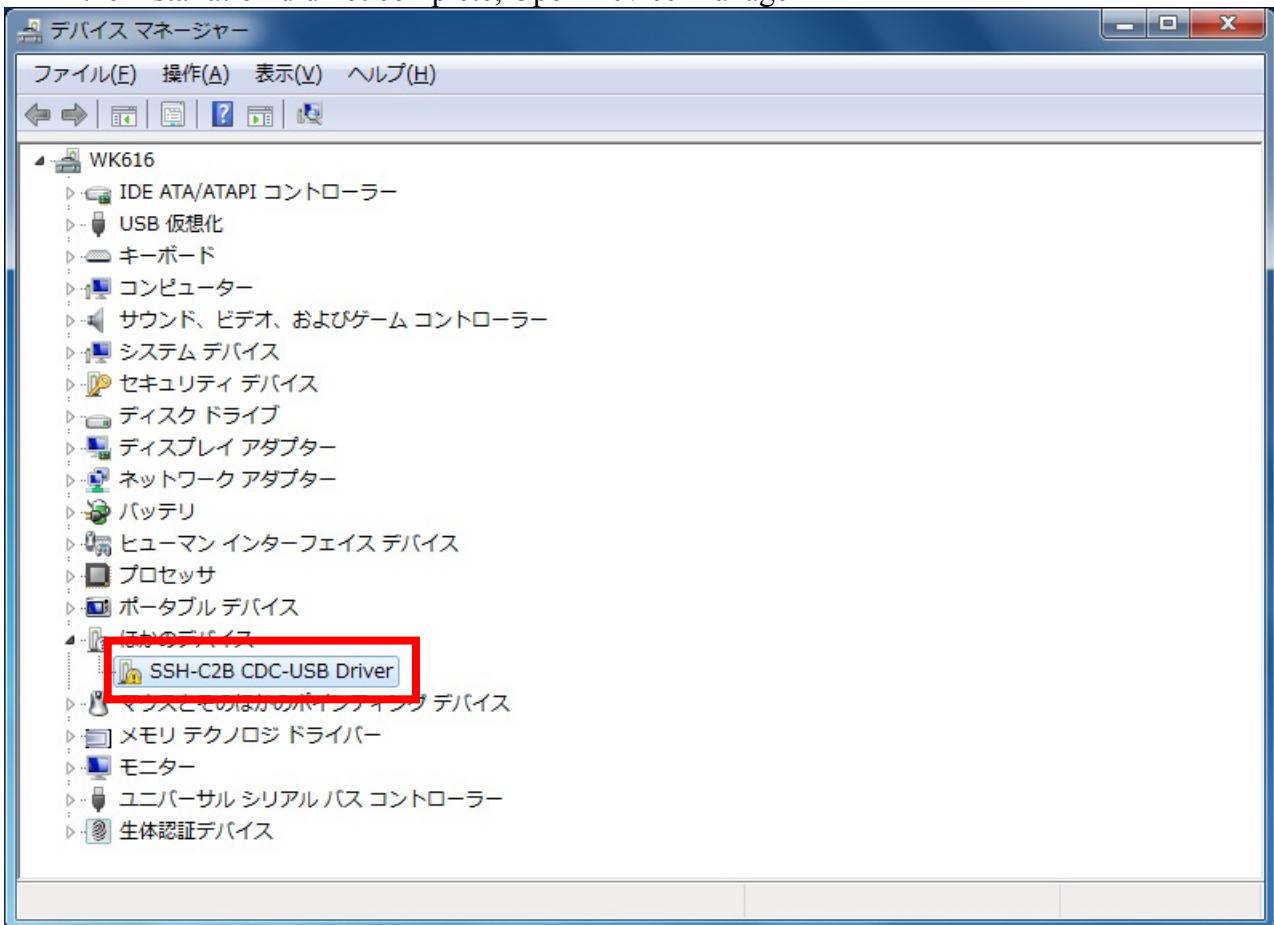

6. Open Properties

Click [renewal of a driver (P)].

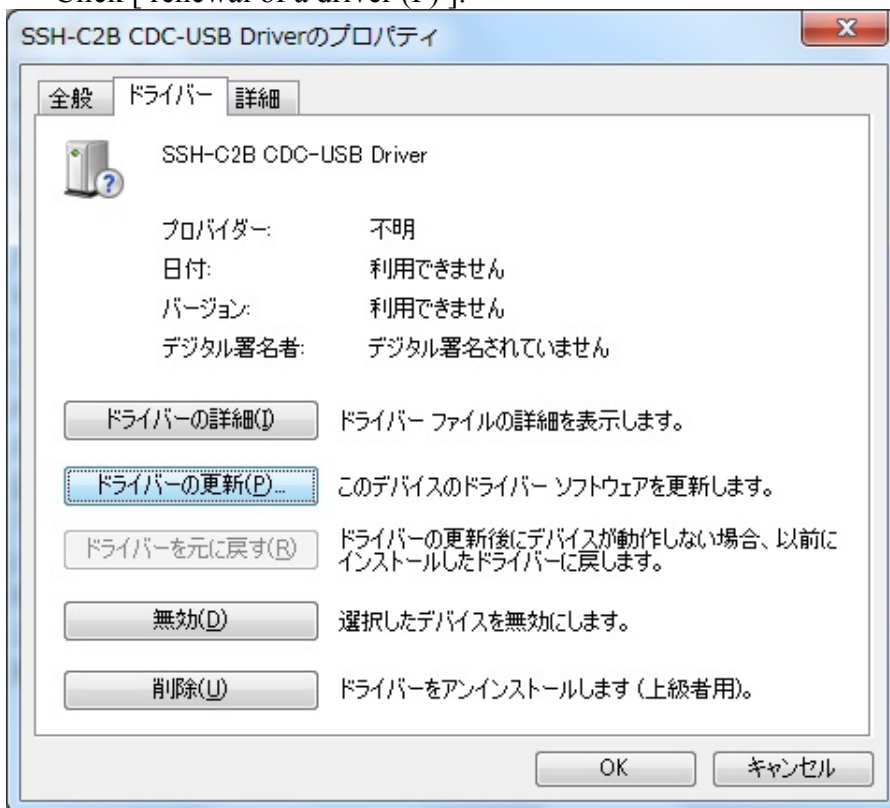

7. Change of Driver

Click [searching driver software manually and installing it].

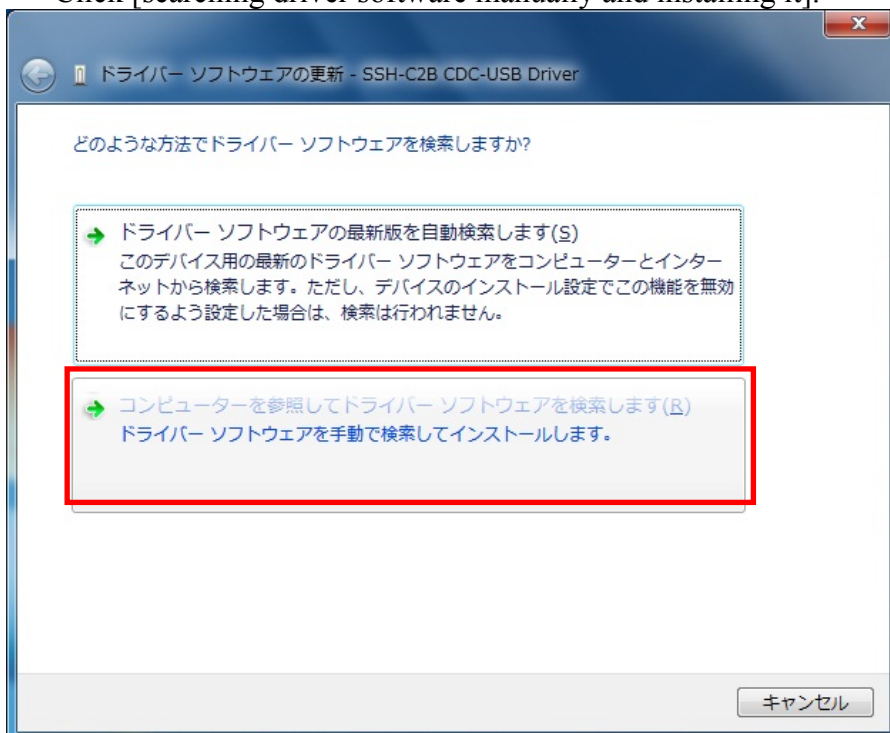

8. Reference to Driver Software

The driver file downloaded to PC is referred to.

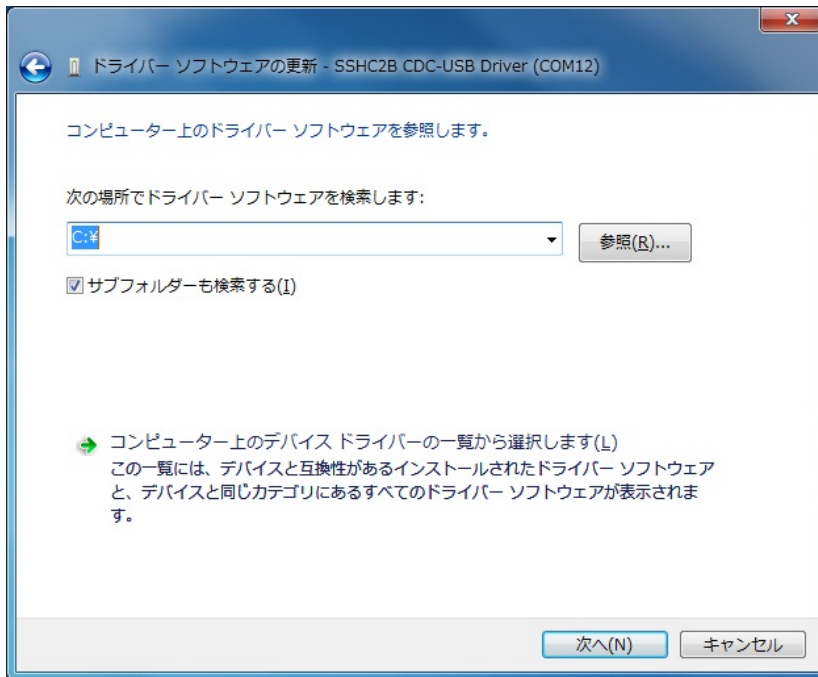

9. Selecting Installation when the security warning is displayed

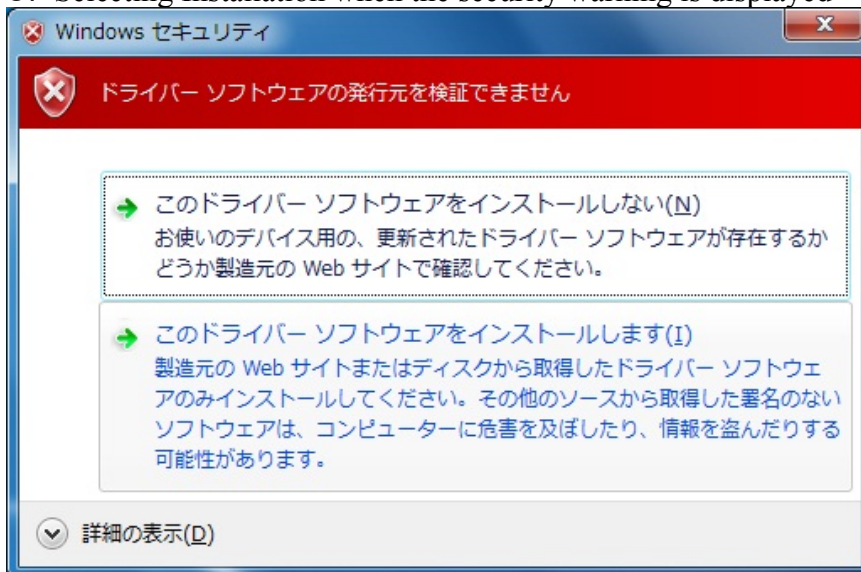

10. Completion of Installation

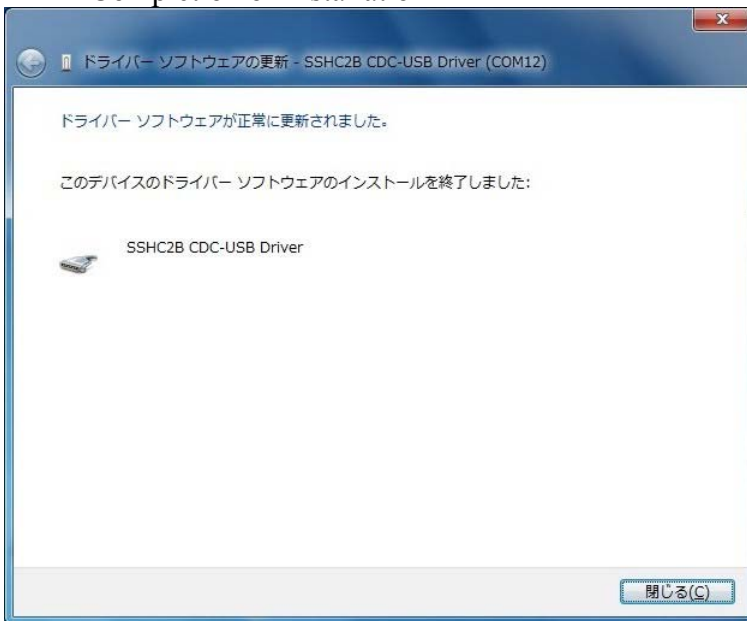

11. When the Installation is completed, please verify COM port number.
(example, COM12 is given)

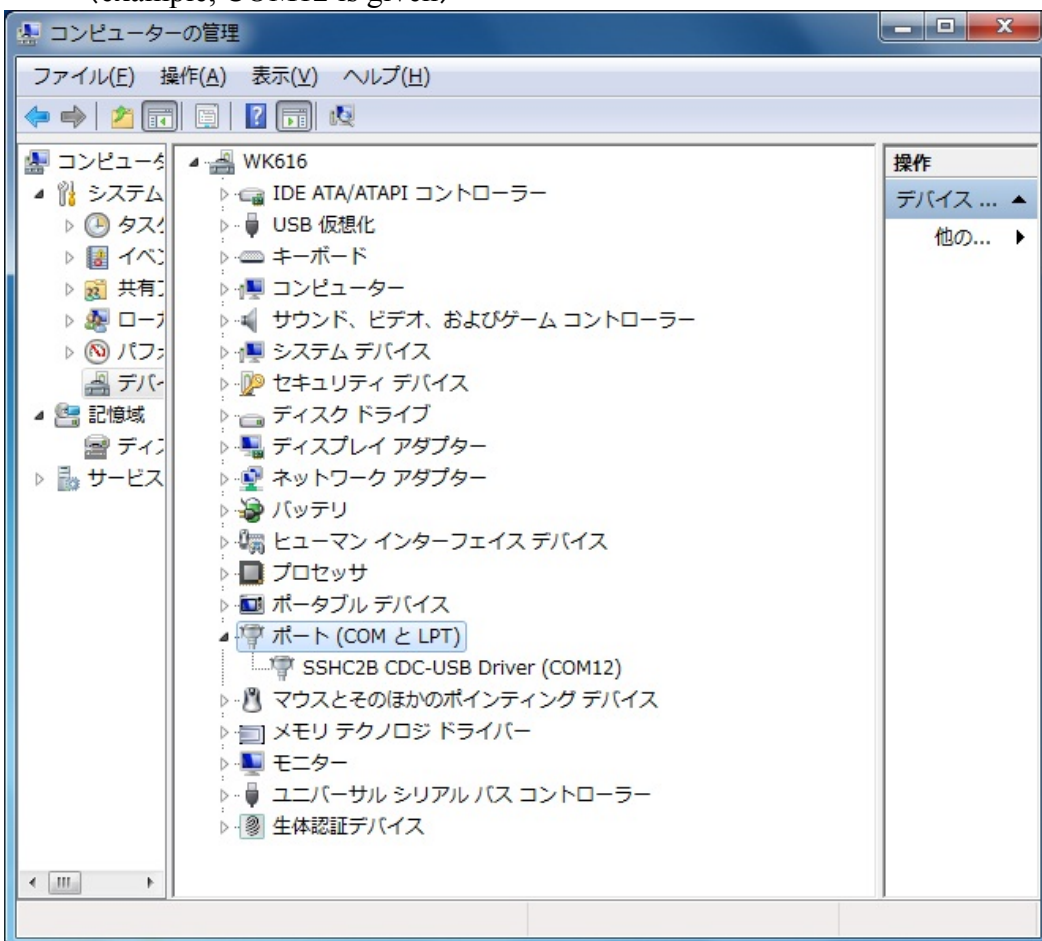

Chapter 5 Demo Application for PC



5-1 Overview

This software is sample software for evaluating the shutter control function of this product. Please download software from our website. The software's operating system is Windows XP/Windows 7 for PC.

This software is available for Simple Mode and Advanced Mode. In Simple Mode, users can manually control the opening and closing of the shutter by selecting the default shutter speed from the list. As for Advanced Mode, the shutter can be operated under more detailed settings.

5-2 Operation Environment

In order to use this software, the PC system must meet the following requirements.

- WindowsXP / Windows7
- USB、or RS232C Interface
- Memory of 1GB or more
- Display of 1024x768 or higher
- NET Framework 2.0 or better

(Download from Microsoft's homepage. Windows7 is not necessary)

5-3 Installation

The order of installation is as follows (for WindowsXP)

1. Double-click 'Installer setup.exe'

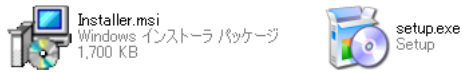

2. Click [Next>] on the displayed window (Fig.5-1).
3. In the next window (Fig.5-2), specify the directory to save the application. Select application user with the radio buttons at the bottom. It usually can be used without the change. When all users are using the PC, select 「Everyone」; just installers select 「Just me」.
4. In clicking [Next>] in the next window(Fig.5-3)installation begins.
5. When installation is complete, the next window (Fig.5-4) is displayed. Click the 「Close」 button.
6. When installation is complete, the icon is added to the desktop (short-cut), as is the application name to the Start Menu (Fig.5-5)

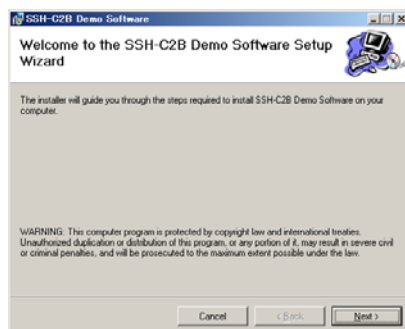

Fig.5-1

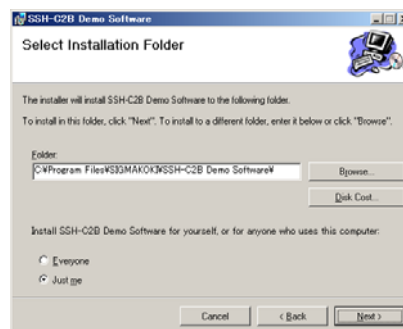

Fig.5-2

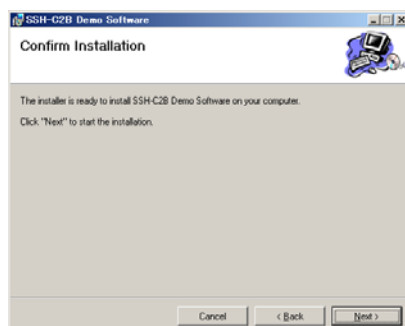

Fig.5-3

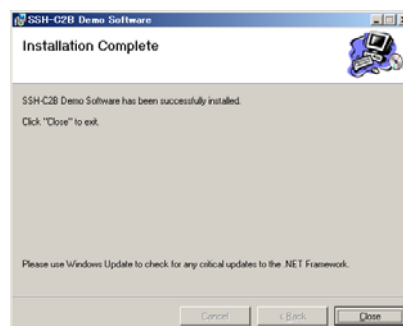

Fig.5-4

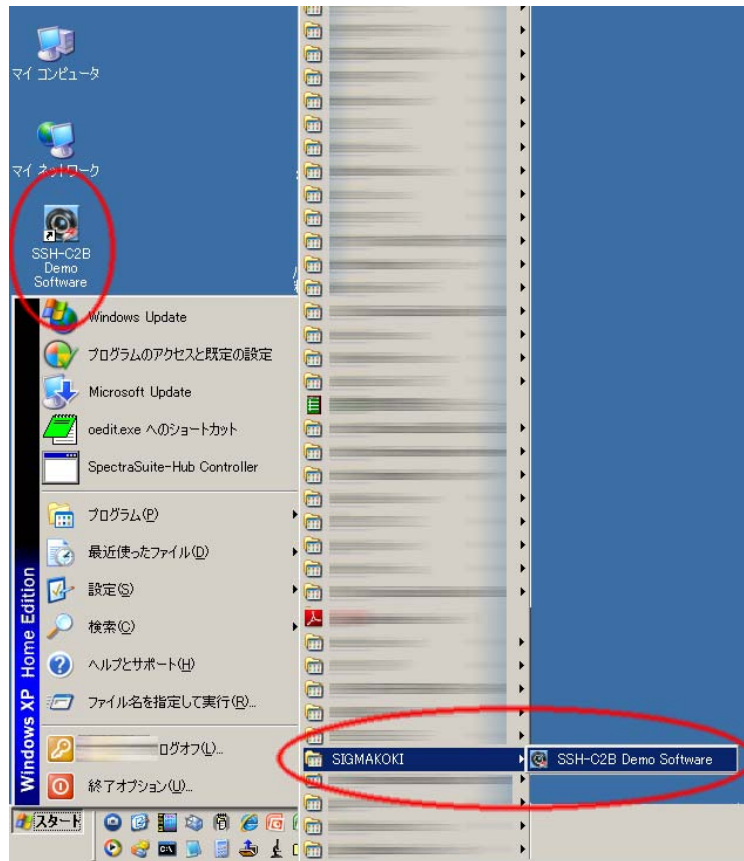

Fig.5-5

5-4 Guideline for Operation Screen

In this section, each item in the operation screen is described.

5-4-1 Connection Window

When the application is launched, at first the Connection window is displayed. The SSH-C2B connection setting is then carried out. If the SSH-C2B does not connect and there is no available COM port, Error is displayed instead of the Connection window.

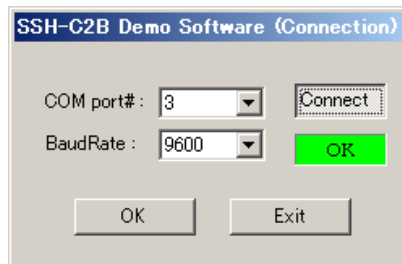

- COM port number: Select the COM port number connected to SSH-C2B. For times other than the first use, the previously used port number appears at first.
- Baud Rate: Select the baud rate that is set to SSH-C2B. For times other than the first use, the previously used Baud Rate appears at first.
- Connect Button: OFF (When not pressed): After performing the abovementioned operations, press this button to check the connection. When the connection is confirmed, the connection status changes to ON and an 「OK」 is displayed in the status display. When connection fails, an 「NG」 is displayed in the status display.
ON (When pressed): The connection is confirmed and available. When the application starts, the previously used setting is recalled and the connection can be automatically checked. At this time, a window appears stating 「OK」.
(Attention) In clicking this button after mistaking it for the Baud rate, clicking the correct Baud rate will still result a failed connection - 「NG」 is displayed. This is because the sent command with the mistaken Baud rate is treated as a faulty command. At this time, please click the Connect button again.
- OK Button: The Main Window (Simple/Advanced) is displayed. Depending on the previous exit status, either the Simple or Advanced window is displayed.
- Exit Button: Closes applications.

- While operating in the Main window, if the controller's power supply is turned off, or if the communication cable is disconnected, you will be returned to this window.

5-4-2 Main Window (Simple Mode)

In this mode, select the shutter speed and then a simple operation screen for controlling only the shutter OPEN/CLOSE will appear. When switched to this screen, Repeat is OFF and the delay time becomes 0ms. As for items that cannot be set in other ways, the value set on the controller is used.

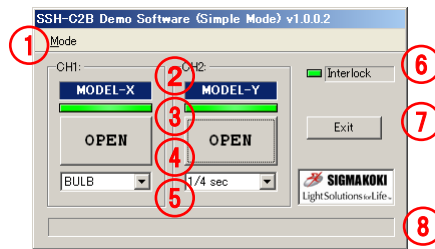

- ①Mode Menu: When 「Advanced」is selected, it changes to Advanced Mode.
- ②Shutter Name Display: The displayed shutter name is set to the current channel.
- ③OPEN Indicator: When the shutter is closed, 「Green」 is displayed. When the shutter is open (including times like delays), 「Red」 is displayed.
- ④OPEN/CLOSE Button: When the shutter is closed, click the OPEN button. When the shutter is open, click the CLOSE button.
- ⑤Shutter Speed Selection Pull-down: Select the shutter speed from the list. In selecting 「BULB」, it is in BULB mode - other items fall under Timer mode. (Attention) When selecting non-configurable shutter speed, an error is displayed. In such cases, please be aware of an unchangeable shutter speed.
- ⑥Interlock Indicator: The status of the Interlock signal is displayed. A normal status is indicated in 「Green」. 「Red」 is the Interlock status.
- ⑦Exit Button: Closes applications.
- ⑧Error Display Area: In case of an error, such is displayed.

5-4-3 Main Window (Advanced Mode)

In this mode, more detailed setting can be applied.

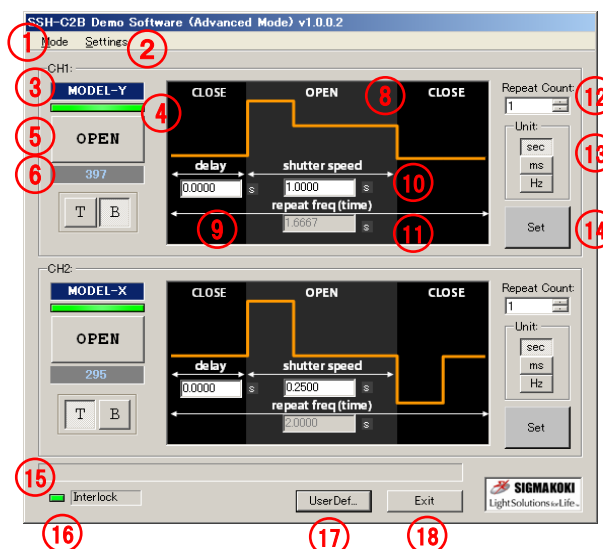

- ①Mode Menu: When 「Simple」 is selected, it turns to Simple Mode. When switched to Simple Mode, Repeat is OFF and the delay time is 0ms.
- ②Setting Menu: When 「Save...」 is selected, The present setting data can be saved at a file. When 「Load...」 is selected, it can read from a file.
Please refer to "5-4-5 Store and Retrieve the Parameters" for the parameter saved.
- ③Shutter Name: The displayed shutter name is set to the current channel.
- ④OPEN Indicator: When the shutter is closed, 「Green」 is displayed. When the shutter is open (including times like delays), 「Red」 is displayed.
- ⑤OPEN/CLOSE Button: When the shutter is closed, click the OPEN button. When the shutter is open, click the CLOSE button. During standby times for delays and repeat operations, though the shutter is closed it is treated as opening.
- ⑥Counter Value Display: The number of times each channel opens/closes (Integrated Value) is displayed.
- ⑦T(Timer)/B(BULB) Button: Timer operation/BULB operation are switched.
- ⑧Sample Waveform Image: The image changes depending on the selected shutter type (TYPE-A/TYPE-B).
- ⑨Delay Input: Input the delay time. When in Hz (units), 0 Hz means no delay (=0.0ms).
- ⑩Shutter Speed Input: Input the shutter speed time
- ⑪Repeat freq(time) Input: Input the repeat time. This parameter is maintained at 0.1Hz unit by the controller. To this end, the input value and the actual value can be disparate.
- ⑫Repeat Count Input: Input the number of times of repeat (1 is no repeat)
- ⑬Unit: Selecting the units for the display and the input values of Delay, Shutter Speed, and Repeat Frequency
- ⑭Set Button: In pressing this button, the setting value in this window is transferred to the controller. When a setting is changed, this button turns Red. If the button is not pressed, the setting value cannot be transferred to the controller. When an non-configurable value is inputted, an error is displayed. When a configurable value is inputted, such success is displayed. When this button is clicked again, the appropriate value can be set.
- ⑮Error Display Area: When there is an error, it is displayed here.
- ⑯Interlock Indicator: The status of the Interlock signal is displayed. A normal status is indicated in 「Green」. 「Red」 is the Interlock status.
- ⑰UserDef... Button: Opens the shutter edit window (refer to "5-4-4 5-4-4 Shutter Edit Window").
- ⑱Exit Button: Closes applications.

※ When the shutter is not selected (「NONE」 is displayed in the shutter name display), the setting of such channel can not be configured.

5-4-4 Shutter Edit Window

In this window, the setting User-defined (No 5 ~7) can be changed, such as voltage and pulse width.

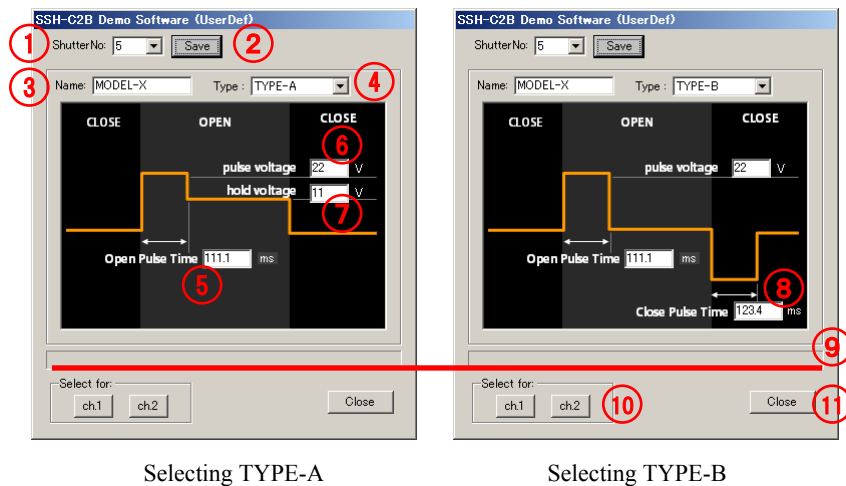

Selecting TYPE-A

Selecting TYPE-B

- ① Shutter No: Selects the shutter number to be edited (confirmable).
- ② Save Button: Press when registering the edited setting into the controller. When the setting is changed, the button's color turns Red. When the button is clicked and the edited setting is transferred without error, the button's color changes back to Gray.
- ③ Name: Input the User-defined shutter name (up to 7 characters). Valid characters are letters (A-Z), numbers (0 to 9), the minus sign (-), underscores (_), the asterisk (*) only. If any other character is entered, it is automatically replaced by underscores. An asterisk is replaced by a space. In case there are fewer than 7 characters, spaces are consequently added.
- ④ Type: Selects the shutter type (TYPE-A/TYPE-B).
- ⑤ Open Pulse Time: Inputs OPEN pulse time.
- ⑥ Pulse voltage: Inputs the value of OPEN pulse voltage. The CLOSE pulse voltage, in the case of TYPE-B shutter, uses the reverse-polarity voltage.
- ⑦ Hold voltage: Inputs the value of OPEN hold voltage (TYPE-A shutter only).
- ⑧ Close Pulse Time: Inputs CLOSE pulse time (TYPE-B shutter Only).
- ⑨ Error Display Area: When there is an error, it is displayed here.
- ⑩ Select Button: Set the currently displayed shutter for the channel.
- ⑪ Close Button: Closes the window, thereby returning to the Main window (Advanced).

5-4-5 Store and Retrieve the Parameters

When 「Save...」 is selected on setting menu, the present setting data can be saved at a file. When 「Load...」 is selected, it can read from a file.

Classification	Setting data
User-defined No.5 ~No.7 (USER1~USER3)	Shutter Name (USER* NAME)
	Open pulse time (USER* T-op)
	Close pulse time (USER* T-cp)
	Pulse voltage (USER* V-pulse)
	Hold voltage (USER* V-hold)
	Shutter type (USER* TYPE)
Configuration of chanel (CH1 , CH2)	Shutter mode (CH* MODE)
	Shutter speed (CH* SPEED)
	Delay time (CH* DELAY)
	Number of repetitions (CH* REP-CNT)
	Frequency of repetitions (CH* REP-FRQ)
	Shutter model (CH* MODEL)
Configuration of system	External input mode (IO MODE)
	External input signal polarity (IO ACTIVE)
	LCD backlight (LCD LIGHT)
	Button LED lighting (BUTTON LIGHT)

The following settings are not saved and restored.

- Command mode: Because it is automatically switched to SSH-C2B command mode when this application is operated.
- Serial port baud rate: Applications software may not operate properly if the baud rate is changed.

5-4-6 Caution

During software operations, if the parameters that are manipulated by the setting mode at the front panel (controller) are changed, such parameters are not reflected in the window display.

Chapter 6 Specifications

6-1 General Specifications

Rating output	DC24V
AC adapter	AC90V~240V (50/60Hz)
Apparent power	120VA
Operating temperature	5°C~40°C
Storage Temperature	-20°C~60°C
Ambient humidity	20~80%RH (Non condensing)
Dimensions(D×W×H)	228×220×90 mm
Weight	1.82kg (AC adapter not include)

6-2 Performance Specification

• Number of control shutter	2ch
• Shutter type	Electronic shutter (TYPE-A) / Electronic shutter (TYPE-B) / other type
• Display	LCD(with white backlight)
• Backlight setting	ON / 5sec ON / OFF
• Serial communication	RS232C、USB 2.0 Full Speed Compliance
• External input	0 - 5V Input 2ch (BNC)
• External output	0 – 5V Sync Output 2ch (BNC)
• External input control system	GATE / TRIGGER
• Polarity of external input	Active High / Active Low
• Shutter pulse voltage	5V~24V
• Shutter hold voltage	5V~24V ※ Hold voltage cannot be set higher than pulse voltage
• Shutter control current	0.5A(Current limit 1A)
• Repeat frequency	0.1~500.0Hz
• Delay time	0.1ms~999.9ms
• OPEN pulse time	0.1ms~999.9ms
• CLOSE pulse time	0.1ms~999.9ms
• Shutter-speed	0.2ms~99990s (MAX = 1666.5min = 27hour46.5min)
• Integrated numbers of Open/Close	MAX 1,000,000,000 count 1 count for Open/Close, each CH can be reset
• Cable length	Maximum 4m at shutter driven
• Alarm	Internal error
• InterLock	Unlock at Short-circuit, All shutters are closed at Interlock status.

•Communications parameter	Baud rate	9600/ 19200/ 38400bps
	Data bit	8bit
	Parity	None
	Stop bit	1bit
	Flow control	RTS/CTS
	Delimiters	CR+LF

6-3 Connector Pin Specifications

OUTPUT

Pin number	Name
1	TYPE-A +
2	TYPE-A +
3	TYPE-B +
4	TYPE-B -

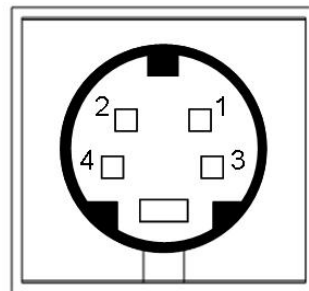

Using Connector TCS7147-012177 (equivalent to the product of Hosiden)

USB

Pin Number	Name
1	VBUS
2	-DATA
3	+DATA
4	GND

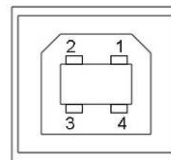

Using Connector XM7B-0442 (equivalent to the product of OMRON)

RS232C

Pin Number	Name
1	NC
2	TxD(OUT)
3	RxD(IN)
4	NC
5	Ground
6	NC
7	CTS(IN)
8	RST(OUT)
9	NC

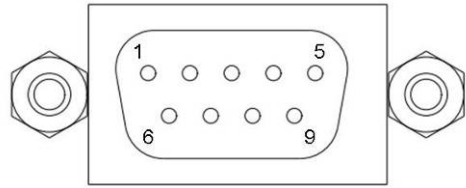

Using Connector XM3B-0942-502L (equivalent to the product of OMRON)

EXT IN

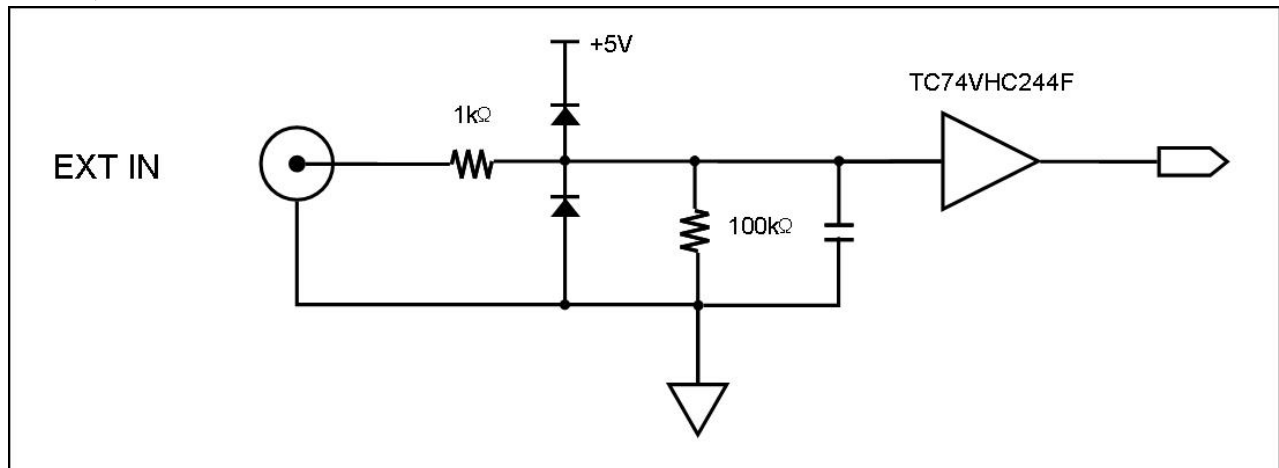

Using Connector BNCS003C00 (equivalent to the product of JAE)

SYNC OUT

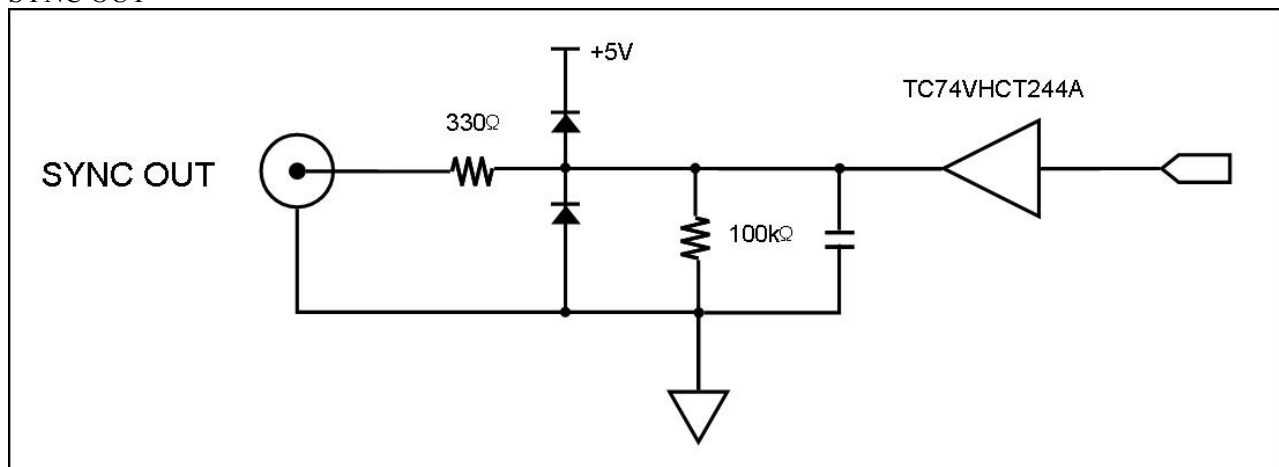

Using Connector BNCS003C00 (equivalent to the product of JAE)

6-4 Dimensions

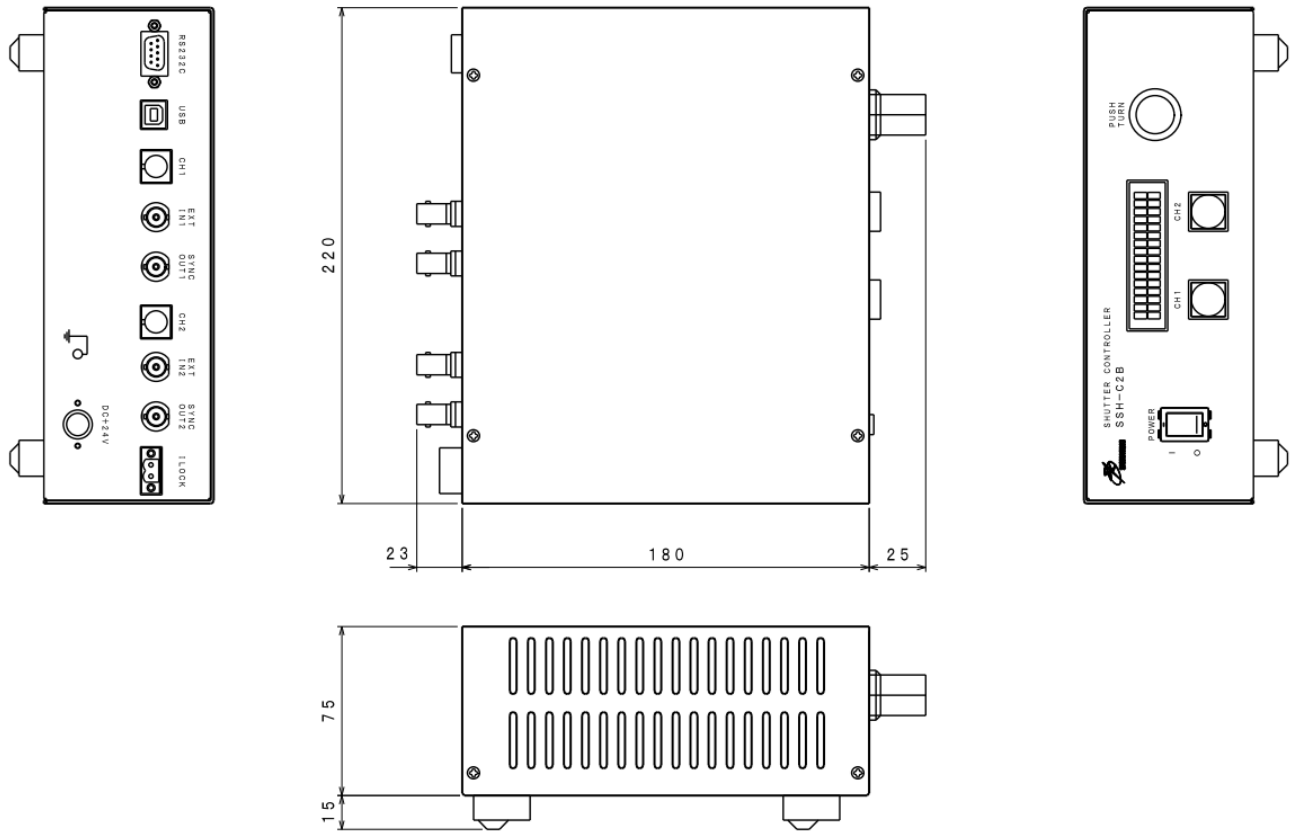

Chapter 7 Others

7-1 Trouble Shooting

① When the display of LCD and the shutter button LED light are operated strangely.

Interlocked with the shutter opening and closing, LCD display is changed and button LED is flashed. When controlled by the fast shutter speed, there would be able to see that LCD display does not match, and LED light is weak or always flashed.

② When a TYPE-B shutter does not close

There is a possibility that the configurations of the shutter type is set to TYPE-A. The TYPE-B shutter's output is Pin No. 3 (common with Pin No. 1), Pin No. 4. If the problem remains, please double-check the wiring.

③ When repeat operation is not performed.

Please set the number of repetitions and the frequency of repetitions. If this does not solve the problem, it is possible the device is not set to TIMER mode. Moreover, with the TYPE-A shutter, when the repeat frequency is maximized, the shutter can always be open. In case of TYPE-A shutter, if repeat frequency is maximized, it would be always opened. For opening and closing, please set the shutter speed to time lesser than that of the repeat frequency.

④ When serial communication is impossible

- In case of non-connection, it can be considered that wiring and/or communication parameter are wrong. Please check the status of right connection and correspond the communication parameter of PC with this product.

- If a communication error is displayed, it can be considered that a command system, a command and/or a parameter are wrong. Please check which command system, "SSH-C 2B or SSH-C4B" is used. If the command system, which was set, is same as sending command system, please check whether it is inputted correctly.